

# Servomotors

## EX Series

### Technical Manual

#### PVD 3665 - EX

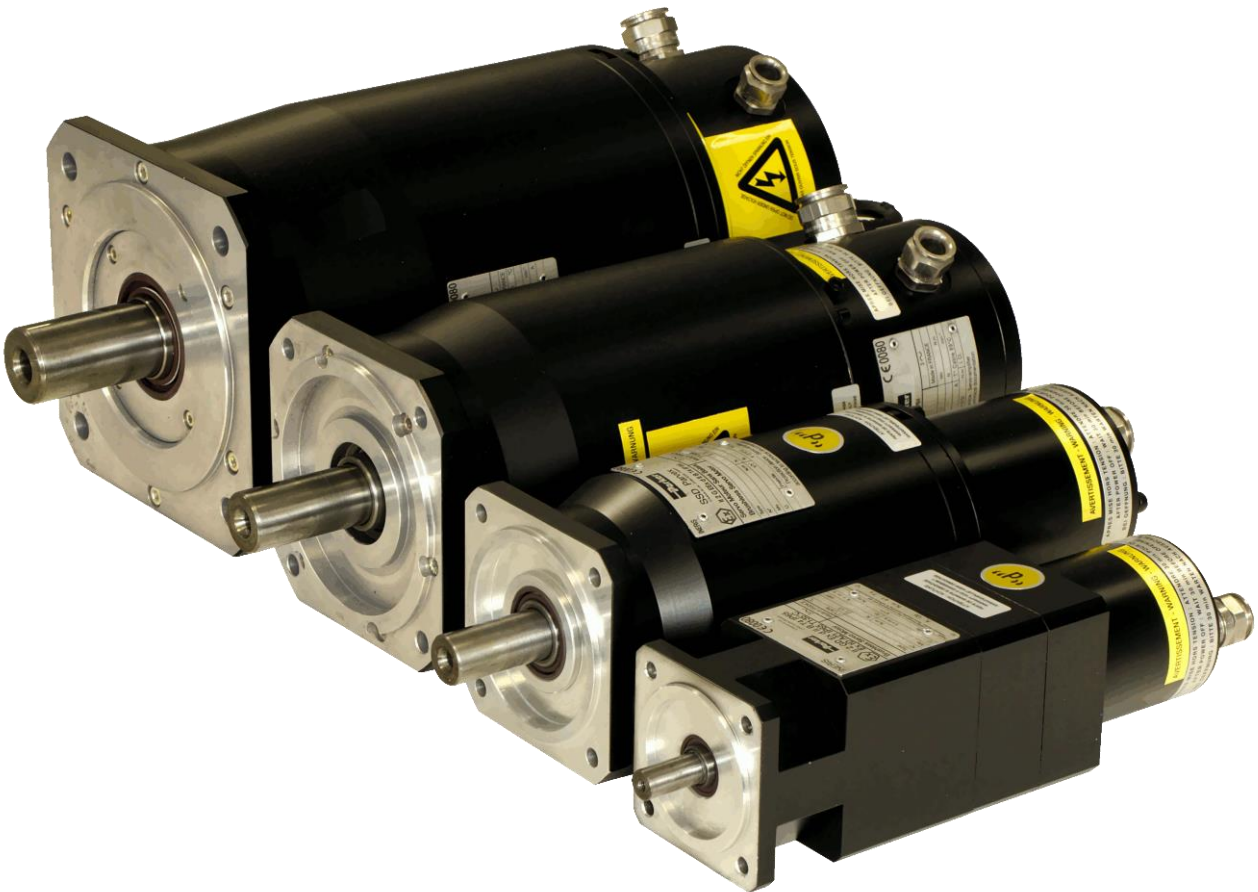



## EU DECLARATION OF CONFORMITY

We,

**Parker Hannifin Manufacturing France SAS**  
**Electromechanical & Drives Division Europe**  
**Etablissement de Longvic**  
**4 Boulevard Eiffel - CS40090**  
**21604 LONGVIC Cedex - France**

manufacturer, with brand name Parker, declare under our sole responsibility that the products,

**SERVOMOTORS TYPE EX3 - EX4 - EX6 with the following marking :**

 II 2 G / Ex db IIB T4 Gb IP64  
or  
 II 2 GD / Ex db IIB T4 Gb IP65 / Ex tb IIIC T135°C Db IP65

satisfy the arrangements of the directives :

Directive 2014/35/EU : "Low Voltage Directive", LVD  
Directive 2011/65/EU : "Restriction of Hazardous Substances", RoHS  
Directive 2014/34/EU : "Equipment and protective systems intended for use in potentially explosive atmospheres"

and meet standards or normative document according to :

IEC 60034-1:2010 / EN 60034-1:2010/AC:2010 : Rotating electrical machines - Part 1 : Rating and performance.  
IEC 60034-5:2000 / EN 60034-5:2001/A1:2007 : Rotating electrical machines - Part 5 : Degrees of protection provided by the integral design of rotating electrical machines (IP code) - Classification.  
IEC 60079-0:2011 / EN 60079-0:2012 : Explosive atmospheres - Part 0 : Equipment - General requirements.  
IEC 60079-1:2014 / EN 60079-1:2014 : Explosive atmospheres - Part 1 : Equipment protection by flameproof enclosures "d".  
IEC 60079-31:2013 / EN 60079-31:2014 : Explosive atmospheres - Part 31 : Equipment dust ignition protection by enclosure "t".

EX3 EC-Type Examination certificate : INERIS 03ATEX0060X + addition 1 to 4.  
EX4 EC-Type Examination certificate : INERIS 04ATEX0097X + addition 1 to 6.  
EX6 EC-Type Examination certificate : INERIS 04ATEX0032X + addition 1 to 5.  
Quality system notification ; INERIS body EC 0080.

The undersigned certify that the above mentioned model is procured in accordance with the above directives and standards.



The servomotors type EX3 - EX4 - EX6 are also certified IECEx.  
IECEx Certification : INE 15.0060X

Further information :

For an ambient temperature of -20°C to +40°C the servomotors shall be mounted on a mechanical support providing good heat conduction and not exceeding 40° C in the vicinity of the motor flange.  
For an ambient temperature of -20°C to +60°C the servomotors shall be mounted on a mechanical support providing good heat conduction and not exceeding 60° C in the vicinity of the motor flange.

The product must be installed in accordance with the instructions and recommendations contained in the operating instructions PVD3665 supplied with the product.

1<sup>st</sup> Motor CE marking :

EX3 C.E. Marking in : June 04<sup>th</sup> 2003  
EX4 C.E. Marking in : January 24<sup>th</sup> 2005

EX6 C.E. Marking in : March 09<sup>th</sup> 2004

Longvic, August 29<sup>th</sup> 2016

In the name of Parker  
A. ANDRIOT  
Quality Manager

Ref : DCEEX-002rev1

## EU DECLARATION OF CONFORMITY

We,

**Parker Hannifin Manufacturing France SAS**  
Electromechanical & Drives Division Europe  
Etablissement de Longvic  
4 Boulevard Eiffel - CS40090  
21604 LONGVIC Cedex - France

manufacturer, with brand name Parker, declare under our sole responsibility that the products,

**SERVOMOTORS TYPE EX8 with the following marking :**

II 2 G Ex d IIB T4 IP64  
or  
II 2 GD Ex d IIB T4 IP65 Ex tD A21 IP65 T135°C

satisfy the arrangements of the directives :

Directive 2014/35/EU : "Low Voltage Directive", LVD  
Directive 2011/65/EU : "Restriction of Hazardous Substances", RoHS  
Directive 2014/34/EU : "Equipment and protective systems intended for use in potentially explosive atmospheres"

and meet standards or normative document according to :

EN 60034-1:2010/AC:2010 : Rotating electrical machines - Part 1 : Rating and performance.  
EN 60034-5:2001/A1:2007 : Rotating electrical machines - Part 5 : Degrees of protection provided by the integral design of rotating electrical machines (IP code) - Classification.  
EN 60079-0:2006 : Electrical apparatus for explosive gas atmospheres - General requirements.  
EN 60079-1:2004 : Electrical apparatus for explosive gas atmospheres - Flameproof enclosures "d".  
EN 61241-0:2006 : Electrical apparatus for use in the presence of combustible dust - General requirements.  
EN 61241-1:2004 + corrigendum 2006 : Electrical apparatus for use in the presence of combustible dust - Protection by enclosures "tD".

The product is not impacted by the modifications made on the latest standards harmonized, therefore it stays conform to the essential requirements regarding the healthy and the safety to the directive 2014/34/EU.

EX8 EC Certification : INERIS 05ATEX0061X  
Quality system notification ; INERIS body EC 0080.

The undersigned certify that the above mentioned model is procured in accordance with the above directives and standards.

Further information :

SERVOMOTORS shall be mounted on a mechanical support providing good heat conduction and not exceeding 40° C in the vicinity of the motor flange.

The product must be installed in accordance with the instructions and recommendations contained in the operating instructions supplied with the product.

EX8 C.E. Marking in : May 30<sup>th</sup> 2005

Longvic, June 29<sup>th</sup> 2016

Ref : DCEEX-001rev1

In the name of Parker  
A. ANDRIOT  
Quality Manager



## Compliance with «UL» standards

# CERTIFICATE OF COMPLIANCE

**Certificate Number** 20151001-E302760  
**Report Reference** E302760-20090203  
**Issue Date** 2015-OCTOBER-01

**Issued to:** PARKER HANNIFIN MANUFACTURING FRANCE SAS  
ESTABLISHMENT LONGVIC  
4 Bd EIFFEL  
21600 LONGVIC FRANCE

**This is to certify that  
representative samples of**

MOTORS, SPECIALTY FOR USE IN HAZARDOUS  
LOCATIONS  
Brushless servo motors - Models EX310, EX420, EX430,  
EX620, EX630, EX 820, EX 840, EX 860 followed by U,  
followed by A through Z, followed by A through Z, followed  
by R, followed by 1, followed by 2 or 5, followed by code 02  
through 99, for use in Hazardous (Classified) Locations,  
Class I, Groups C & D.

Have been investigated by UL in accordance with the  
Standard(s) indicated on this Certificate.

**Standard(s) for Safety:** UL 674, Electric Motors and Generators for Use in Division  
1 Hazardous (Classified) Locations.  
CAN/CSA C22.2 No. 145-M1986, Motors and Generators  
for Use in Hazardous Locations .

**Additional Information:** See the UL Online Certifications Directory at  
[www.ul.com/database](http://www.ul.com/database) for additional information

Only those products bearing the UL Certification Mark should be considered as being covered by UL's  
Certification and Follow-Up Service.

Look for the UL Certification Mark on the product.



Bruce Mahrenholz, Director North American Certification Program

UL LLC

Any information and documentation involving UL Mark services are provided on behalf of UL LLC (UL) or any authorized licensee of UL. For questions, please  
contact a local UL Customer Service Representative at <http://ul.com/about/locations/>



## Compliance with «UL» standards

# CERTIFICATE OF COMPLIANCE

**Certificate Number** 20151001-E242959  
**Report Reference** E242959-20070608  
**Issue Date** 2015-OCTOBER-01

**Issued to:** PARKER HANNIFIN MANUFACTURING FRANCE SAS  
ESTABLISHMENT LONGVIC  
4 Bld EIFFEL  
21600 LONGVIC FRANCE

**This is to certify that  
representative samples of**

COMPONENT - INCOMPLETE ROTATING MACHINES  
AND ROTATING MACHINE PARTS  
COMPONENT - SERVO AND STEPPER MOTORS  
Brushless servo motor - Models EX310, EX420, EX430,  
EX620, EX630, EX 820, EX 840, EX 860 followed by U;  
followed by A through Z, followed A through Z, followed by  
R, followed by code 1 for EX3-EX4-EX6-EX8 motors,  
followed by code 2 or 5 and B or E, followed by code 02  
through 99

Have been investigated by UL in accordance with the  
Standard(s) indicated on this Certificate.

**Standard(s) for Safety:** UL 1004-1, Rotating Electrical Machines - General  
Requirements  
C22.2 No. 100-04, Motors and Generators

**Additional Information:** See the UL Online Certifications Directory at  
[www.ul.com/database](http://www.ul.com/database) for additional information

Only those products bearing the UL Certification Mark should be considered as being covered by UL's  
Certification and Follow-Up Service.

Recognized components are incomplete in certain constructional features or restricted in performance  
capabilities and are intended for use as components of complete equipment submitted for investigation rather  
than for direct separate installation in the field. The final acceptance of the component is dependent upon its  
installation and use in complete equipment submitted to UL LLC.

Look for the UL Certification Mark on the product.



Bruce Mahrenholz, Director North American Certification Program  
UL LLC

Any information and documentation involving UL Mark services are provided on behalf of UL LLC (UL) or any authorized licensee of UL. For questions, please  
contact a local UL Customer Service Representative at [http://ul.com/about/ul\\_locations/](http://ul.com/about/ul_locations/).



# Table of Content

<b>1. INTRODUCTION.....</b>	<b>8</b>
1.1. Purpose and intended audience .....	8
1.2. Safety .....	9
1.2.1. Principle .....	9
1.2.2. General Safety Rules .....	9
1.2.3. Safe Torque Off function .....	10
1.2.4. Operating category and marking of EX servomotors .....	11
1.2.5. Special conditions for the ATEX servomotors .....	13
<b>2. PRODUCT DESCRIPTION.....</b>	<b>14</b>
2.1. Quick URL .....	14
2.2. Overview.....	14
2.3. Applications .....	14
2.4. General Technical Data for ATEX motors .....	15
2.5. General Technical Data for UL motors.....	16
2.6. Product Code .....	17
<b>3. TECHNICAL DATA .....</b>	<b>18</b>
3.1. Motor selection .....	18
3.1.1. ATEX standard atmospheric conditions .....	18
3.1.2. Altitude derating.....	18
3.1.3. Temperature derating .....	18
3.1.4. Thermal equivalent torque (rms torque) .....	18
3.1.5. Servo drive selection .....	20
3.1.6. Current limitation at stall conditions (i.e. speed < 3 rpm) .....	24
3.1.7. Peak current limitations .....	24
3.2. EX Characteristics: Torque, speed, current, power .....	25
3.2.1. ATEX/IECEX 230V .....	26
3.2.2. ATEX/IECEX 400V .....	27
3.2.3. UL 230V .....	28
3.2.4. UL 400V .....	28
3.2.5. Further Data.....	29
3.2.6. Efficiency curves.....	30
3.2.7. Electromagnetic losses.....	41
3.2.8. Time constants of the motor .....	42
3.2.9. Speed ripple.....	44
3.2.10. Cogging torque .....	44
3.2.11. Rated data according to rated voltage variation .....	45
3.2.12. Voltage withstand characteristics of EX series.....	47
3.2.13. Voltage and current during the operating .....	48
3.3. Dimension drawings .....	50
3.3.1. EX310E .....	50
3.3.2. EX420E EX430E .....	51
3.3.3. EX620E EX630E .....	52
3.3.4. EX820E EX840E EX860E .....	53
3.3.5. EX310U .....	54
3.3.6. EX420U EX430U .....	55
3.3.7. EX620U EX630U .....	56
3.3.8. EX820U EX840U EX860U .....	57
3.4. Motor Mounting .....	58
3.4.1. Motor mounting.....	58
3.4.2. Installation of ATEX machines.....	58
3.4.3. Frame recommendation .....	59
3.5. Shaft Loads .....	60
3.5.1. Vibration resistance to shaft end .....	60
3.5.2. Maximum load acceptable on the shaft.....	60
3.6. Cooling .....	61
3.7. Thermal Protection .....	62
3.8. Power Electrical Connections .....	63
3.8.1. Inlet cables for ATEX/IECEX version. ....	63
3.8.2. Wires sizes .....	63
3.8.3. Conversion Awg/kcmil/mm <sup>2</sup> : .....	64
3.8.4. Motor cable length .....	64
3.8.5. Mains supply connection diagrams .....	65

3.8.6.	ATEX/IECEX motor conenction .....	73
3.8.7.	EX3-EX4 UL connection .....	77
3.8.8.	EX6-EX8 UL connection .....	79
3.9.	Feedback system .....	81
3.9.1.	Shaft rotation regarding the connection. ....	81
3.9.2.	Resolver 2 poles transformation ratio = 0.5 – code A .....	81
3.9.3.	Sensorless – code K or Y. ....	81
3.9.4.	Hiperface encoder singleturn SKS36 (128pulses) – code R .....	82
3.9.5.	Hiperface encoder multiturn SKM36 (128pulses) – code S .....	82
3.9.6.	Hiperface encoder singleturn SRS50 (1024pulses) – code T .....	83
3.9.7.	Hiperface encoder multiturn SRM50 (1024pulses) – code U .....	83
3.9.8.	Endat encoder singleturn ECN1113 – code V .....	84
3.9.9.	Endat encoder multiturn ECN1125 – code W .....	84
3.9.10.	Incremental encoder - Commuted lines 10 poles – 2048pulses – code X (On request) .....	86
3.10.	Cables .....	87
3.10.1.	Cable option Max 80°C on the surface ATEX/IECEX .....	88
3.10.2.	Resolver cable connection for AC890 .....	89
3.10.3.	Endat cable connection for AC890 .....	89
3.10.4.	Resolver cable connection for COMPAX3 .....	90
3.10.5.	Hiperface encoder cable connection for COMPAX3 .....	90
3.10.6.	Resolver cable connection for SLVD .....	91
3.10.7.	Resolver cable connection for 637/638 .....	91
3.10.8.	Hiperface encoder cable connection for 637/638 .....	92
3.10.9.	Feedback cable reference .....	92
3.10.10.	Power cable for AC890 .....	93
3.10.11.	Power cable for COMPAX3 .....	93
3.10.12.	Power cable for SLVD .....	94
3.10.13.	Power cable for 637/638 .....	94
3.10.14.	Power cable reference .....	95
3.11.	Brake option .....	96
<b>4.</b>	<b>COMMISSIONING, USE AND MAINTENANCE .....</b>	<b>97</b>
4.1.	Instructions for commissioning, use and maintenance .....	97
4.1.1.	Equipment delivery .....	97
4.1.2.	Handling .....	97
4.1.3.	Storage .....	98
4.2.	Installation .....	98
4.2.1.	Mounting .....	98
4.2.2.	Torque value for the screws .....	98
4.2.3.	Preparation .....	99
4.2.4.	Mechanical assembly .....	99
4.3.	Electrical connections .....	100
4.3.1.	Cable connection .....	101
4.3.2.	Encoder cable handling .....	101
4.3.3.	Connection diagrams .....	102
4.3.4.	Cable glands informations (Only ATEX/IECEX) .....	104
4.3.5.	UL Electrical commissioning .....	106
4.4.	Maintenance Operations .....	107
4.4.1.	Summary maintenance operations .....	107
4.4.2.	Informations about the flameproof enclosure components .....	108
4.4.1.	ATEX flameproof joints informations ATEX/IECEX .....	108
4.5.	Troubleshooting .....	109

# 1. INTRODUCTION





## 1.1. Purpose and intended audience

This manual contains information that must be observed to select, install, operate and maintain PARKER EX servomotors.

Installation, operation and maintenance of the equipment should be carried out by qualified personnel. A qualified person is someone who is technically competent and familiar with all safety information and established safety practices; with the installation process, operation and maintenance of this equipment; and with all the hazards involved.

Reading and understanding the information described in this document is mandatory before carrying out any operation on the motors. If any malfunction or technical problem occurs, that has not been dealt with in this manual, please contact PARKER for technical assistance. In case of missing information or doubts regarding the installation procedures, safety instructions or any other issue tackled in this manual, please contact PARKER as well.

PARKER's responsibility is limited to its servomotors and does not encompass the whole user's system. Data provided in this manual are for product description only and may not be guaranteed, unless expressly mentioned in a contract.

	<p><b><u>DANGER:</u></b> PARKER declines responsibility for any accident or material damage that may arise, if the procedures and safety instructions described in this manual are not scrupulously followed.</p>
	<p><b><u>Motors for ATEX zones :</u></b> Servomotors type EX manufactured for the European market are designed to operate in ATEX classified zones</p>
	<p><b><u>Motors for hazardous classified locations :</u></b> EX servomotors manufactured for the North American market are designed to operate in hazardous classified areas.</p>
	<p><b><u>Motors for Ex zones :</u></b> Servomotors type EX manufactured off European and North American markets are designed to operate in Ex classified zones.</p>





## 1.2. Safety







### 1.2.1. Principle

To operate safely, this equipment must be transported, stored, handled, installed and serviced correctly. Following the safety instructions described in each section of this document is mandatory. Servomotors usage must also comply with all applicable standards, national directives and factory instructions in force.

	<p><b><u>DANGER:</u></b> Non-compliance with safety instructions, legal and technical regulations in force may lead to physical injuries or death, as well as damages to the property and the environment.</p>
---	--

### 1.2.2. General Safety Rules

	<p><b>Generality</b>  <b><u>DANGER:</u></b> The installation, commission and operation must be performed by qualified personnel, in conjunction with this documentation.</p> <p>The qualified personnel must know the safety (C18510 authorization, standard VDE 0105 or IEC 0364) and local regulations.</p> <p>They must be authorized to install, commission and operate in accordance with established practices and standards.</p>
	<p><b>Electrical hazard</b></p> <p>Servo drives may contain non-insulated live AC or DC components. Respect the drives commissioning manual. Users are advised to guard against access to live parts before installing the equipment.</p> <p>Some parts of the motor or installation elements can be subjected to dangerous voltages, when the motor is driven by the inverter , when the motor rotor is manually rotated, when the motor is driven by its load, when the motor is at standstill or stopped.</p> <p>For measurements use only a meter to IEC 61010 (CAT III or higher). Always begin using the highest range. CAT I and CAT II meters must not be used on this product.</p> <p>Allow at least 5 minutes for the drive's capacitors to discharge to safe voltage levels (&lt;50V). Use the specified meter capable of measuring up to 1000V dc &amp; ac rms to confirm that less than 50V is present between all power terminals and between power terminals and earth.</p> <p>Check the drive recommendations.          The motor must be permanently connected to an appropriate safety earth. To prevent any accidental contact with live components, it is necessary to check that cables are not damaged, stripped or not in contact with a rotating part of the machine. The work place must be clean, dry.</p> <p>General recommendations :</p> <ul style="list-style-type: none"> <li>- Check the wiring circuit</li> <li>- Lock the electrical cabinets</li> <li>- Use standardized equipment</li> </ul>

	<p><b>Mechanical hazard</b> Servomotors can accelerate in milliseconds. Running the motor can lead to other sections of the machine moving dangerously. Moving parts must be screened off to prevent operators coming into contact with them. The working procedure must allow the operator to keep well clear of the danger area.</p>
	<p><b>Burning Hazard</b> Always bear in mind that some parts of the surface of the motor can reach a temperature of 135°C.</p>
	<p><b>Generality</b> The installation and operation must be made with the <i>Commissioning and use manual</i> given with the motor.  Commissioning and use manual of the EX motor series : - EX8 Atex : PVD 3571</p>
	<p><b>Atex servomotors</b> This motor can be used in hazardous areas. May particular attention to the notes marked with  .</p>
	<p>European directive 99/92/EC makes explicit the responsibility of employers to protect employees who may be exposed to risk of ATEX environments (Explosive Atmosphere). The employer must assess the risk and classify potentially dangerous areas. Equipment and materials must also be suited for use in dangerous areas in accordance with ATEX directives 94/9/EC and 2014/34/EU.</p>

### 1.2.3. Safe Torque Off function

The safe torque off function in accordance with the standards EN ISO 13849-1 : 2006 and EN 61800-5-2 : 2006 is an electronic system set up on some drives certified by a notified body. This is an unlocked input placed on the drive that must be connected (see the commissioning and use manual of the drive).

The servomotors EX are equipped with a thermal protection which is checked by a safety analysis and is a key element of the ATEX/IECEx safety. It is possible to connect this protection to the unlocked input or through a safety system in accordance to the drive specifications. This connection allows to maintain the drive power on, but disable the motor after the activation of the thermal protection.

After an activation of this security device, the system must not restart automatically and without a checking of the installation.

In all cases, the connection of this device must be checked and certified by a notified body.

**1.2.4. Operating category and marking of EX servomotors**

**1.2.4.1. EX3-EX4-EX6 ATEX/IECEX gaseous atmospheres**



**II 2 G Ex db IIB T4 Gb IP64**

<b>II</b>		<b>2</b>	<b>G</b>	<b>Ex</b>	<b>db</b>	<b>II</b>	<b>B</b>	<b>T4</b>	<b>Gb</b>	<b>IP65</b>
<b>I Mines</b>	M1 Very high level of protection	<b>G</b> Gas/Vapour	<b>ATEX</b> protection	<b>o</b> Oil immersion	<b>I Mines</b>	Methane	T1 450 °C	Ma Very high level of protection	<b>IP64</b>	
	M2 High level of protection			<b>p</b> Pressurized apparatus				T2 300 °C		Mb High level of protection
<b>II Surface</b>	<b>1</b> Very high level of protection			<b>db</b> Flameproof enclosure	<b>II Surface Gas</b>	<b>A</b> Propane	T3 200 °C	Ga Very high level of protection		
	<b>2</b> High level of protection			<b>e</b> Increased safety		<b>B</b> Ethylene	<b>T4</b> 135 °C	<b>Gb</b> High level of protection		
	<b>3</b> Normal level of protection			<b>m</b> Encapsulation		<b>C</b> Hydrogen Acetylene	T5 100 °C	Gc Normal level of protection		
				<b>i</b> Intrinsic safety			T6 85 °C			

Suitable for ATEX/IECEX servomotors

### 1.2.4.2. EX3-EX4-EX6 ATEX/IECEX dusty atmospheres



**II 2 GD Ex db IIB T4 Gb IP65 / Ex tb IIIC T135°C Db IP65**

II	2	D	Ex	tb	III	C	T135 °C	Db	IP65
I Mines	M1 Very high level of protection	D Combustible dust	ATEX protection	ta Protection by enclosure	III Dust	A Combustible flying	T1 450 °C	Ma Very high level of protection	IP65
	M2 High level of protection			tb / tc Protection by enclosure			T2 300 °C	Mb High level of protection	
II Surface	1 Very high level of protection			B Non conductive dust		pb / pc Pressurized enclosure	T3 200 °C	Da Very high level of protection	
	2 High level of protection					ia / ib / ic Intrinsic safety	<b>T4</b> 135 °C	Db High level of protection	
	3 Normal level of protection					ma / mb / mc Encapsulation	T5 100 °C	Dc Normal level of protection	
				T6 85 °C					

Suitable for ATEX/IECEX servomotors

### 1.2.4.3. EX8 ATEX

Gazous atmosphere	<p><b>II 2 G Ex d IIB T4 IP64</b></p> <ul style="list-style-type: none"> <li>- II Outside industries</li> <li>- 2 Intermittent presence of gas</li> <li>- d Explosionproof</li> <li>- II B Ethylene or propane</li> <li>- T4 135°C for the Max. temperature on the motor surface</li> <li>- IP64 or IP65 Protection index</li> </ul>
Dust atmosphere	<p><b>II 2 D Ex tD A21 T135°C IP65</b></p> <ul style="list-style-type: none"> <li>- tD Protection by enclosure</li> <li>- A21 Protection with seal</li> <li>- T135°C 135°C for the Max. temperature on the motor surface</li> <li>- IP65 Protection index</li> </ul>

### 1.2.5. Special conditions for the ATEX servomotors

	<p>The EC certifications are marked with a <b>X</b>. It seems the using of the motor must be in accordance with special conditions explained below:</p> <p>In case of fail of a screw used to assemble the parts of the flameproof enclosure, the new part must have a quality class superior or equal to 8.8.</p> <p>In case of an using in dusty explosive atmospheres, the user must perform regular cleaning operations on the motor to avoid dust deposits.</p>
---	--

#### 1.2.5.1. UL



**Class1 group C&D Code T4A**

Class I	Division 1	Group C&D	T4A	IP65
Class I Gaz, vapours ou liquids	Division 1 Explosive atmospheres can exist all the time or some of the time under normal operating conditions	A Acetylene	T1 450°C	IP65
		B Hydrogen	T2 300°C	
			T3 200°C	
	Division 2 Explosive atmospheres cannot exist under normal operating conditions	C Ethylene	T4 135°C	
			T4A 120°C	
		D Propane	T5 100°C	
T6 85°C				

	Suitable for UL servomotors
--	-----------------------------

## 2. PRODUCT DESCRIPTION

### 2.1. Quick URL

All informations and datas are available on :

<http://www.parker.com/eme/ex>

### 2.2. Overview

The EX servomotors from Parker are specifically designed to operate in explosive atmospheres for industrial applications.

The EX motors are brushless synchronous servomotors, with permanent magnets, based on NX active parts.

A large set of torque / speed characteristics, options and customization possibilities are available, making EX servomotors the ideal solution for most servosystems applications in explosive atmospheres.

#### Advantages

- High precision
- High motion quality
- High dynamic performances
- Low cogging
- Compact dimensions and robustness
- Large set of options and customization possibilities
- CE, IECEx and UL marking certification available.

### 2.3. Applications

**Painting applications**

**Packaging machinery**

**Robot applications**

**Special machines**

**Cleaning applications**

**Printing applications**

**Actuator for valve in Oil&Gas and Energy applications**

## 2.4. General Technical Data for ATEX motors

	EX3, EX4, EX6	EX8
<b>Motor type</b>	Permanent-magnet synchronous motor	
<b>Magnets material</b>	Neodymium Iron Boron	
<b>Number of poles</b>	10	
<b>Type of construction</b>	IMB5 – IMV1 – IMV3 (EN60034-7)	
<b>Degree of protection</b>	<ul style="list-style-type: none"> <li>• Gaseous atmosphere : IP64, IP65</li> <li>• Combustible dust atmosphere : IP65</li> </ul>	
<b>Cooling</b>	Natural cooling	
<b>Rated voltage</b>	230VAC, 400 VAC	
<b>Insulation of the stator winding</b>	Class F according to IEC 60034-1	Class F according to IEC 60034-1 with potting
<b>Altitude</b>	Up to 1000m (IEC 60034-1) No allowed for higher altitude	
<b>Ambiant temperature</b>	-20°C to +40°C -20°C to +60°C with performances derating	
<b>Storage temperature</b>	-20°C to +60°C	
<b>Connection</b>	Electronic plate with cable glands	
<b>Marking</b>	CE and IECEx	
<b>Paint</b>	Black RAL9005	
<b>Sensor</b>	<ul style="list-style-type: none"> <li>• Resolver as a standard</li> <li>• Sick encoder - Hiperface: SKS36 and SKM36 SRS50 and SRM50 – on request and not available for EX3</li> <li>• Heidenhain Endat encoder: ECN1113 and EQN1125 – on request and not available for EX3 and EX4</li> <li>• Sensorless</li> <li>• Incremental 2048 pulses and with commutation (10 poles) – on request</li> </ul>	
<b>Brake</b>	Parking brake as an option	
<b>Thermal protection</b>	Thermoswitches + thermofuse	
<b>Remark</b>	Numerous customization are possible on request (special shaft, special flange,...)	

## 2.5. General Technical Data for UL motors

	EX3, EX4, EX6	EX8
<b>Motor type</b>	Permanent-magnet synchronous motor	
<b>Magnets material</b>	Neodymium Iron Boron	
<b>Number of poles</b>	10	
<b>Type of construction</b>	IMB5 – IMV1 – IMV3 (CEI 60034-7)	
<b>Degree of protection</b>	IP65	
<b>Cooling</b>	Natural cooling	
<b>Rated voltage</b>	230VAC, 400 VAC, 480 VAC	
<b>Insulation of the stator winding</b>	Class F according to IEC 60034-1	Class F according to IEC 60034-1 with potting
<b>Altitude</b>	Up to 1000m (IEC 60034-1)	
<b>Ambiant temperature</b>	-20°C to +40°C	
<b>Storage temperature</b>	-20°C to +60°C	
<b>Connection</b>	Electronic plate with threaded holes	
<b>Marking</b>	UL	
<b>Paint</b>	Without	
<b>Sensor</b>	<ul style="list-style-type: none"> <li>• Resolver as a standard</li> <li>• Sick encoder - Hiperface: SKS36 and SKM36 SRS50 and SRM50 – on request and not available for EX3</li> <li>• Heidenhain Endat encoder: ECN1113 and EQN1125 – on request and not available for EX3 and EX4</li> <li>• Sensorless</li> </ul>	
<b>Brake</b>	Parking brake in option	
<b>Thermal protection</b>	Thermoswitches + thermofuse	
<b>Remark</b>	Numerous customization are possible on request (special shaft, special flange,...)	



## 2.6. Product Code

The EX servomotors are defined by its electrical and mechanical characteristics, by its accompanying accessories and by any customer specificity. This information is coded and entered in the “Type” column on the manufacturer’s plate for the basic codification; the specificities are entered in a separate column.

Code	E	X	3	1	0	E	A	K	R	1	2	0	0
<b>Product Series</b>	—												
<b>Motor size</b>	—												
1, 2, 3, 4, 6 or 8 in relation with the motor diameter													
<b>Motor length</b>	—												
up to 60 depend on size													
<b>Motor version</b>	—												
E: ATEX/IECEEx motor U: UL motor													
<b>Feedback Sensor</b>	—												
A: resolver 2 poles transformation ratio = 0.5 K: without sensor R: Hiperface encoder singleturn SKS36 (128pulses) S: Hiperface encoder mutiturn SKM36 (128pulses) T: Hiperface encoder singleturn SRS50 (1024pulses) U: Hiperface encoder mutiturn SRM50 (1024pulses) V: Endat encoder singleturn ECN1113— on request W: Endat encoder multiturn ECN1125— on request X: Incremental 2048ppr and with commutation – on request Y: sensorless series for 650S drive Z : Special encoder													
<b>Torque / Speed Characteristics</b>	—												
See motor data													
<b>Painting</b>	—												
R: no painting B: Black painting													
<b>Electric connection</b>	—												
1: Cable gland or threaded holes (UL)													
<b>Break and thermal sensor option</b>	—												
2: Without brake 5: With brake													
<b>Mechanical Interface</b>	—												
00: IP64 plain shaft 01: IP64 key on shaft Other: custom code													
10: IP65 with plain shaft 11: IP65 with key on shaft													

## 3. TECHNICAL DATA

### 3.1. Motor selection

#### 3.1.1. ATEX standard atmospheric conditions

EX motors are designed to operate in area:

- with a pressure between 80 kPa (0.8 bar) and 110 kPa (1.1 bar).
- air with normal oxygen content, typically 21 % v/v.
- air with a maximum relative humidity of 80%, without condensation.

In other conditions, please consult us.

#### 3.1.2. Altitude derating

From 0 to 1000 m : no derating

> 1000 m : the EX motors are not designed to operate in hazardous area for this altitude.

#### 3.1.3. Temperature derating

EX servomotors are designed to operate with a maximum ambient temperature of 40°C. In case of using with an ambient temperature above 40°C and less or equal than 60°C, a derating of performances is applied according to data recommended by Parker.

#### 3.1.4. Thermal equivalent torque (rms torque)

The selection of the right motor can be made through the calculation of the rms torque  $M_{rms}$  (i.e. root mean squared torque) (sometimes called equivalent torque).

This calculation does not take into account the thermal time constant. It can be used only if the overload time is much shorter than the copper thermal time constant.

The rms torque  $M_{rms}$  reflects the heating of the motor during its duty cycle.

Let us consider:

- the period of the cycle  $T$  [s],
- the successively samples of movements  $i$  characterized each ones by the maximal torque  $M_i$  [Nm] reached during the duration  $\Delta t_i$  [s].

So, the rms torque  $M_{rms}$  can be calculated through the following basic formula:

$$M_{rms} = \sqrt{\frac{1}{T} * \sum_{i=1}^n M_i^2 \Delta t_i}$$

Example:

For a cycle of 2s at 0 Nm and 2s at 10Nm and a period of 4 s, the rms torque is

$$M_{rms} = \sqrt{\frac{1}{4} * 10^2 * 2} = 7,07 Nm$$

**Illustration :**

Acceleration-deceleration torque: 10 Nm for 0,1 s.  
 Resistant torque: 1 Nm during all the movement.  
 Max-min speed:  $\pm 2800$  rpm during 0,2 s.  
 Max torque provided by the motor: 11 Nm.  
 rms torque: 6 Nm.

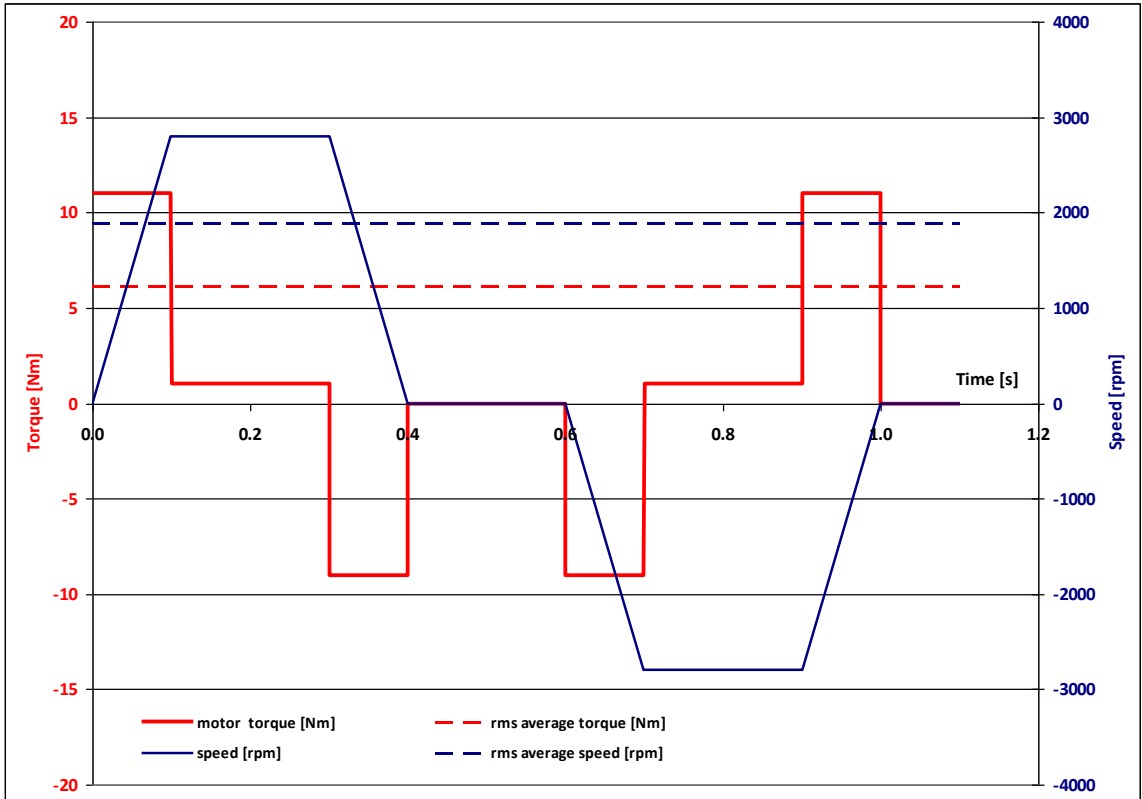

The maximal torque  $M_i$  delivered by the motor at each segment  $i$  of movement is obtained by the algebraic sum of the acceleration-deceleration torque and the resistant torque. Therefore,  $M_{max}$  corresponds to the maximal value of  $M_i$ .

**Selection of the motor :**

The motor adapted to the duty cycle has to provide the rms torque  $M_{rms}$  at the rms speed(\*) without extra heating. This means that the permanent torque  $M_n$  available at the average speed presents a sufficient margin regarding the rms torque  $M_{rms}$ .

$$\Omega_{rms} = \sqrt{\frac{1}{T} * \sum_{i=1}^n \Omega_i^2 \Delta t_i}$$

(\*) rms speed is calculated thanks to the same formula as that used for the rms torque. The mean speed cannot be used (in general mean speed is equal to zero). Only use the rms speed.

Furthermore, each  $M_i$  and speed associated  $\Omega_i$  of the duty cycle has to be located in the operational area of the torque vs speed curve.

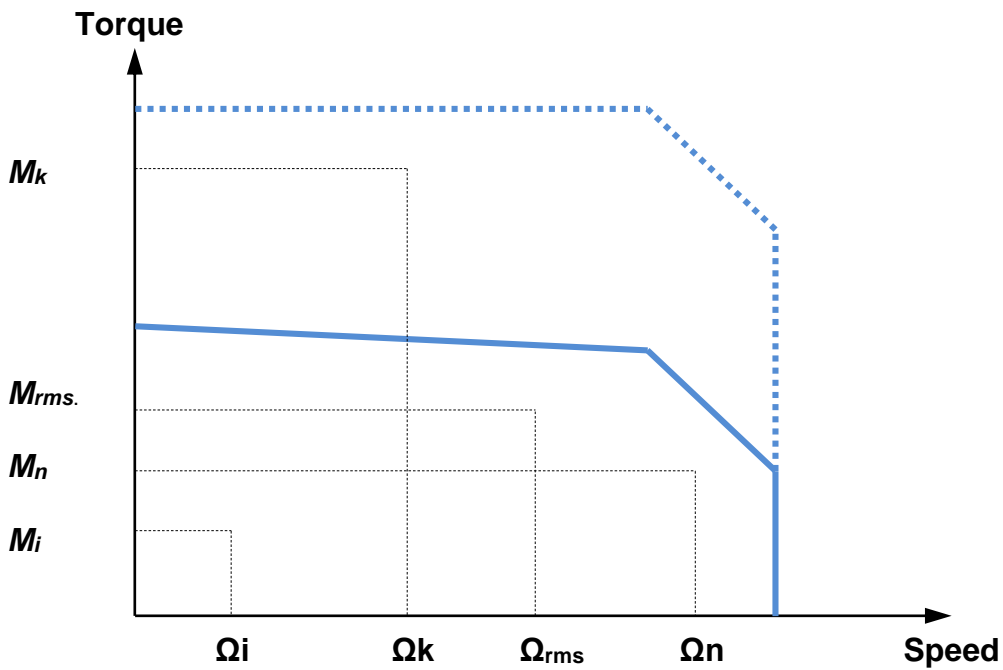

### **3.1.5. Servo drive selection**

Selection of drive depends on its rated power, rated current and its mode selection which leads to the maximal current duration.



Please refer to the drive technical documentation for any further information and to select the best motor and drive association.

**AC890 PARKER drive example:**

The rated current provided by the AC890 drive depends on its rated power and its mode selection. “Vector mode” is used for induction motors while “Servo mode” is used for brushless AC motors. With EX motors the power is usually < 37 kW, the rated current corresponds to 100 %.

Power of Drive AC890 [kW]	< 37 kW
Mode	Servo mode
Overload capability [%]	200 % during 4 s

**Illustration:**

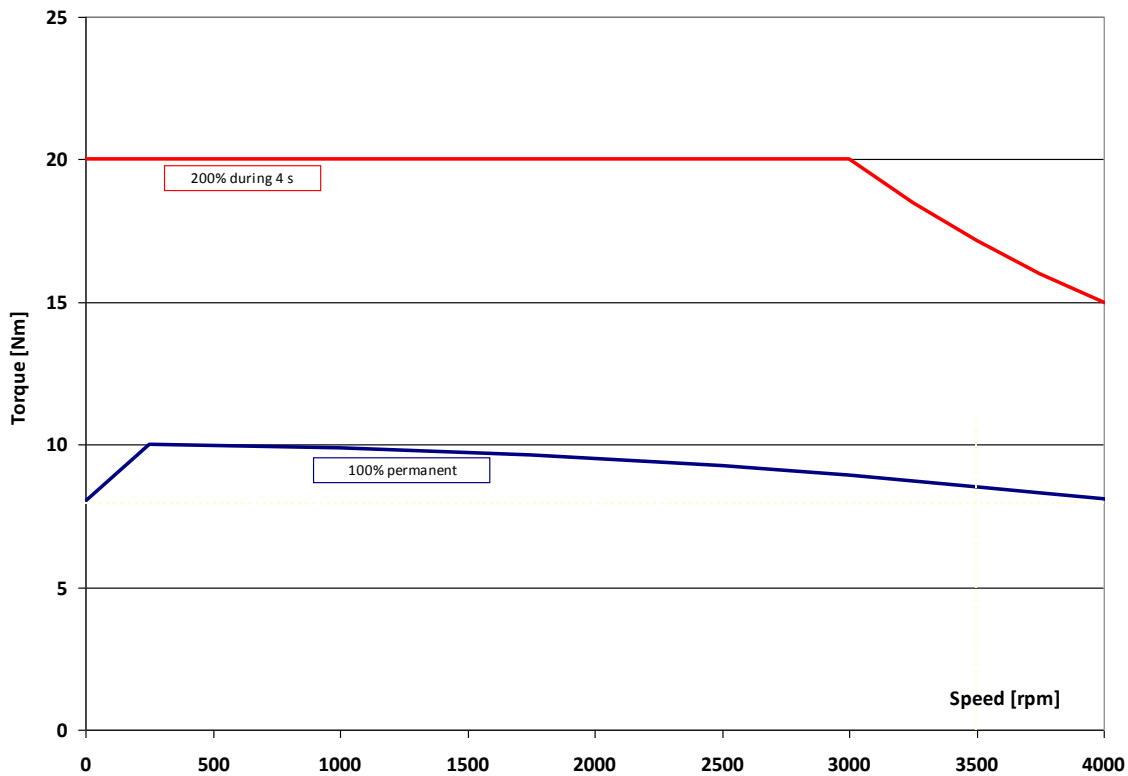



**Example n°1 :**

The application needs:

- a rms torque of **7 Nm** at the rms speed of 2000 rpm,
- an acceleration torque of **10 Nm**,
- a maximal speed of 2800 rpm.

**Selection of the motor:**

The selected motor is the type **EX620EAO**.

The nominal speed is equals to 4300 rpm.

The maximal speed is equals to 4300 rpm.

The torque sensitivity is equals to 1.27 Nm/Arms.

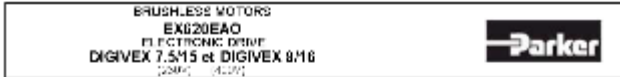

BRUSHLESS MOTORS				No UL certification	
EX620EAO					
ELECTRONIC DRIVE					
DIGIVEX 7.5A15 et DIGIVEX 8A16					
(220V - 400V)					
Torque at low speed	$M_0$	Nm	7		
Permanent current at low speed	$I_0$	Arms	5.51		
Peak torque	$M_p$	Nm	14.7	-	
Current for the peak torque	$I_p$	Arms	11.3	-	
Back emf constant at 1000 rpm (25°C)	$K_e$	V/rpm	21.7		
Torque sensitivity	$K_t$	Nm/Arms	1.27		
Winding resistance (25°C)	$R_s$	$\Omega$	1.63		
Winding inductance	$L_s$	mH	34		
Motor inertia	$J$	kgm <sup>2</sup> 10 <sup>-4</sup>	98		
Thermal time constant	$\tau_{th}$	min	27		
Motor mass	$M$	kg	11.3		
Voltage of the mains	UN 0 220V0	V rms	230	400	-
Rated speed	$n_n$ (rpm)	rpm	2500	4300	-
Rated torque	$M_n$ (Nm)	Nm	3.49	3.13	-
Rated current	$I_n$ (Arms)	Arms	4.47	2.75	-
Rated power	$P_n$ (W)	W	1440	1410	-

All data are given in typical conditions unless otherwise specified.  
 \* Data by request  
 † Voltage and current are given in rms value

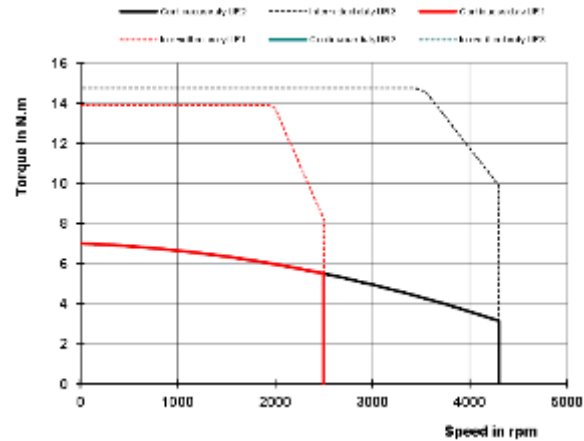

The permanent current  $I_0$  of the motor is **5.51 Arms** for  $M_0=7$  Nm at low speed.

The nominal current  $I_n$  of the motor is **2.46 Arms** for  $M_n= 3.13$  Nm at the nominal speed.

**Selection of the drive:**

The drive has to provide at least a permanent current equals to  $I_0$  (5.51 Arms).

In order to obtain an acceleration torque of **10 Nm**, the current will be about 8 Arms. This means that the drive has to provide at least 8 Arms as transient current.

→ Therefore, we can select the drive **AC890SD-53 2100 B** which delivers under 400 VAC:

**6 Arms** as permanent current and

**6\*200%=12 Arms** as maximal transient current during 4 s.

The drive is set with **“Servo Mode”**.

**Example n°2 :**

This times; the application needs :

- a permanent torque of 5 Nm at low speed,
- a rms torque of 5 Nm at the rms speed of 1890 rpm,
- an acceleration torque of **7.6 Nm**,
- a maximal speed of 2800 rpm.

**Selection of the motor:**

The selected motor is the type **EX620EAO**.

The nominal speed is equals to 4300 rpm.

The maximal speed is equals to 4300 rpm.

The torque sensitivity is equals to 1.27 Nm/Arms.

**Selection of the drive:**

The drive has to provide a permanent current equals to 4 Arms to obtain 5 Nm.

In order to obtain an acceleration torque of **7.6 Nm**, the current will be of about 6 Arms

This means that the drive has to provide at less 6 Arms as transient current.

Compared to the previous example n°1, it is now possible to decrease the size of drive.

→ Therefore, we can select the drive **AC890SD-53 1600 B** which delivers under 400 VAC:

**4 Arms** as permanent current and

**4\*200%=8 Arms** as maximal transient current during 4 s.

The drive is set with "**Servo Mode**".

### 3.1.6. Current limitation at stall conditions (i.e. speed < 3 rpm)

Recommended reduced current at speed < 3 rpm:

$$I_{reduced} = \frac{1}{\sqrt{2}} * I_0 \cong 0.7 * I_0$$

	<p><b>Warning:</b> The current must be limited to the prescribed values. If the nominal torque has to be maintained at stop or low speed (&lt; 3 rpm), imperatively limit the current to 70% of <math>I_0</math> (permanent current at low speed), in order to avoid an excessive overheating of the motor.</p>
	<p>Please refer to the drive technical documentation for any further information and to choose functions to program the drive.</p>

### 3.1.7. Peak current limitations

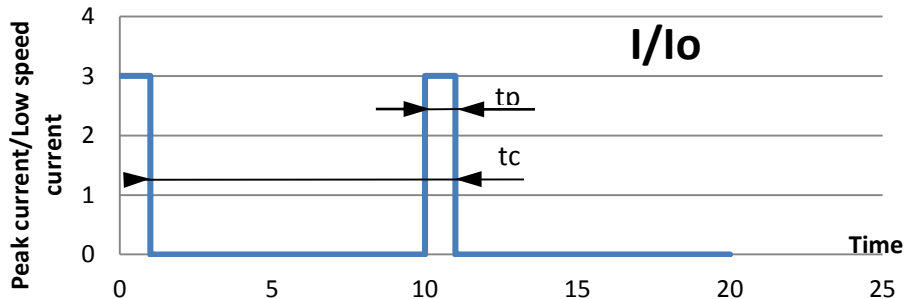

It is possible to use the EX motor with a current higher than the permanent current. But, to avoid any overheating, the following rules must be respected.

- 1) The peak currents and peak torques given in the data sheet must never be exceeded
- 2) The thermal equivalent torque must be respected (§3.1.3)
- 3) If 1) and 2) are respected (it can limit the peak current value or duration), the peak current duration ( $t_p$ ) must be limited, in addition, accordingly to the following table ( $I_0$  is the permanent current at low speed):

$I_{peak}/I_n$	$I_p/I_0 = 2$	$I_p/I_0 = 3$
EX310	$t_p < 0.8 \text{ s}$	$t_p < 0.3 \text{ s}$
EX420		
EX430		
EX620	$t_p < 1.5 \text{ s}$	$t_p < 0.6 \text{ s}$
EX630		
EX820		
EX840		
EX860		

The peak current duration is calculated for a temperature rise of 3°C  
Consult us for more demanding applications.



### 3.2. EX Characteristics: Torque, speed, current, power...

The torque vs speed graph below explains different intrinsic values of the next tables.

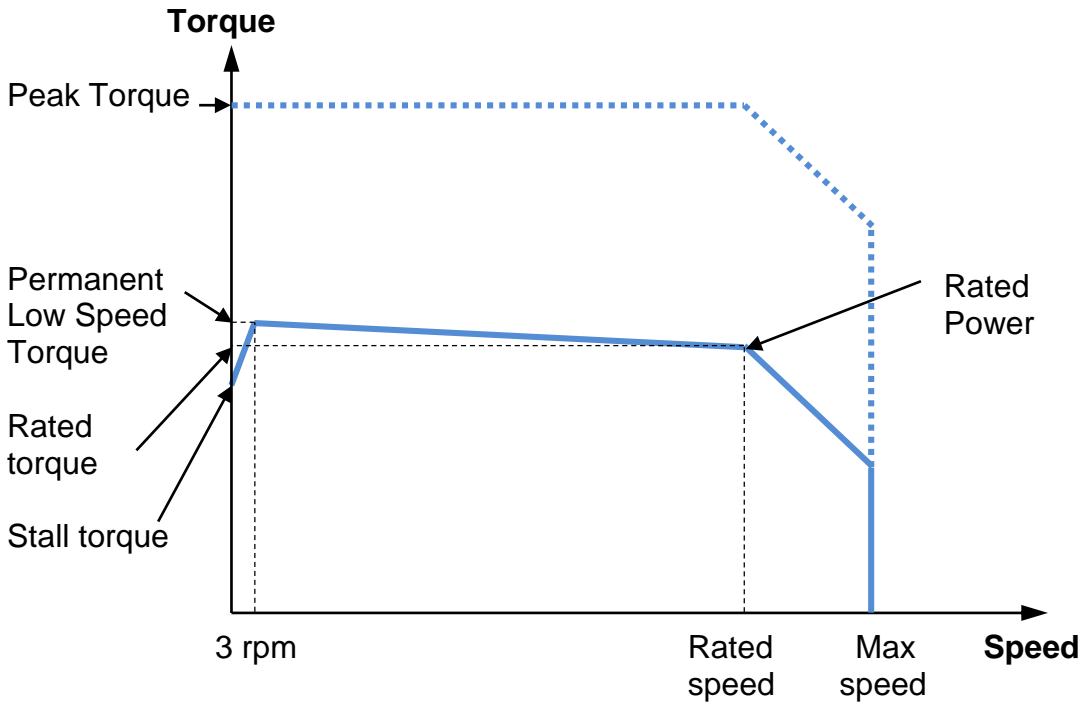

### 3.2.1. ATEX/IECEX 230V

Motor	Rated Power	Rated Torque	Rated Speed	Rated Current	Low Speed Torque	Low speed Current	Peak Torque	Peak Current	Max. Speed
	Pn (kW)	Mn (Nm)	Nn [rpm]	In [Arms]	Mo [Nm]	Io [Arms]	Mpeak [Nm]	I peak [Arms]	Nmax [rpm]
With 40°C ambient temperature									
EX310EAP	0.40	1.66	2300	1.2	1.75	1.2	4.2	3.1	2300
EX310EAK	0.64	1.54	4000	2.0	1.75	2.2	4.2	5.4	4000
EX420EAP	0.77	3.18	2300	2.3	3.5	2.5	8.3	6.2	2300
EX420EAJ	1.12	2.67	4000	3.3	3.5	4.3	8.3	10.7	4000
EX430EAL	1.02	4.2	2300	3.0	4.8	3.3	11.5	8.3	2300
EX430EAF	1.37	3.3	4000	4.1	4.8	5.8	11.5	14.5	4000
EX620EAV	0.76	6.6	1100	2.4	6.7	2.4	16.7	6.0	1100
EX620EAR	1.33	5.8	2200	4.0	6.7	4.5	16.7	11.2	2200
EX630EAR	1.43	9.4	1450	4.2	10.4	4.6	25.9	11.5	1450
EX630EAN	2.02	8.4	2300	5.7	10.4	6.9	25.9	17.3	2300
EX820EAR	2.57	11.2	2200	7.5	14	9.3	32.5	23.2	2200
EX840EAK	3.31	15.8	2000	9.4	24.5	14.3	58.2	35.6	2000
EX860EAJ	3.86	25.4	1450	11.5	35	15.7	83.3	39.2	1450

Motor	Rated Power	Rated Torque	Rated Speed	Rated Current	Low Speed Torque	Low speed Current	Peak Torque	Peak Current	Max. Speed
	Pn (kW)	Mn (Nm)	Nn [rpm]	In [Arms]	Mo [Nm]	Io [Arms]	Mpeak [Nm]	I peak [Arms]	Nmax [rpm]
With 60°C ambient temperature									
EX310EAP	0.31	1.30	2300	0.9	1.75	1.2	4.2	3.1	2300
EX310EAK	0.40	0.95	4000	1.3	1.75	2.2	4.2	5.4	4000
EX420EAP	0.59	2.45	2300	1.8	3	2.1	7.3	5.3	2300
EX420EAJ	0.63	1.5	4000	1.9	3	3.7	7.3	9.1	4000
EX430EAL	0.82	3.4	2300	2.4	4.2	2.9	10.2	7.2	2300
EX430EAF	0.90	2.9	3000	3.6	4.2	5.1	10.2	12.7	4000
EX620EAV	0.63	5.5	1100	2.0	6	2.2	15.0	5.3	1100
EX620EAR	0.88	3.8	2200	2.8	6	4.1	15.0	9.9	2200
EX630EAR	1.12	7.35	1450	3.4	9	4.0	22.5	9.8	1450
EX630EAN	1.24	5.15	2300	3.7	9	6.1	22.5	14.7	2300
EX820EAR	1.65	8.5	1850	5.8	11	7.3	26.6	18.3	2200
EX840EAK	2.23	11.5	1850	6.9	21	12.2	51.0	30.6	2000
EX860EAJ	2.74	18.0	1450	8.3	31	13.9	75.1	34.8	1450

### 3.2.2. ATEX/IECEX 400V

Motor	Rated Power	Rated Torque	Rated Speed	Rated Current	Low Speed Torque	Low speed Current	Peak Torque	Peak Current	Max. Speed
	Pn (kW)	Mn (Nm)	Nn [rpm]	In [Arms]	Mo [Nm]	Io [Arms]	Mpeak [Nm]	I peak [Arms]	Nmax [rpm]
<b>With 40°C ambient temperature</b>									
EX310EAP	0.64	1.54	4000	1.1	1.75	1.2	4.2	3.1	4000
EX310EAK	0.87	1.23	6800	1.6	1.75	2.2	4.2	5.4	6800
EX420EAP	0.94	3	3000	2.1	3.5	2.5	8.3	6.2	3000
EX420EAJ	1.11	1.8	6000	2.3	3.5	4.3	8.3	10.7	6000
EX430EAL	1.37	3.3	4000	2.3	4.8	3.3	11.5	8.3	4000
EX430EAF	1.37	3.3	4000	4.1	4.8	5.8	11.5	14.5	5800
EX620EAV	1.25	6.0	2000	2.2	6.7	2.4	16.7	6.0	2000
EX620EAR	1.53	3.8	3900	2.7	6.7	4.5	16.7	11.2	3900
EX630EAR	2.19	7.8	2700	3.5	10.4	4.6	25.9	11.5	2700
EX630EAN	2.18	5.2	4000	3.8	10.4	6.9	25.9	17.3	4000
EX820EAR	2.84	7.5	3600	5.2	14	9.3	32.5	23.2	3900
EX840EAK	0.99	2.9	3300	2.1	24.5	14.3	58.2	35.6	3500
EX860EAJ	2.35	9.0	2500	4.4	35	15.7	83.3	39.2	2600

Motor	Rated Power	Rated Torque	Rated Speed	Rated Current	Low Speed Torque	Low speed Current	Peak Torque	Peak Current	Max. Speed
	Pn (kW)	Mn (Nm)	Nn [rpm]	In [Arms]	Mo [Nm]	Io [Arms]	Mpeak [Nm]	I peak [Arms]	Nmax [rpm]
<b>With 60°C ambient temperature</b>									
EX310EAP	0.40	0.95	4000	0.7	1.8	1.2	4.2	3.1	4000
EX310EAK	0.40	0.95	4000	1.3	1.8	2.2	4.2	5.4	6800
EX420EAP	0.66	2.1	3000	1.5	3.0	2.1	7.3	5.3	3000
EX420EAJ	0.63	1.5	4000	1.9	3.0	3.7	7.3	9.1	6000
EX430EAL	0.90	2.9	3000	2.0	4.2	2.9	10.2	7.2	4000
EX430EAF	0.90	2.9	3000	3.6	4.2	5.1	10.2	12.7	4900
EX620EAV	0.88	4.2	2000	1.6	6.0	2.2	15.0	5.3	2000
EX620EAR	0.84	3.2	2500	2.4	6.0	4.1	15.0	9.9	3900
EX630EAR	1.18	4.5	2500	2.2	9.0	4.0	22.5	9.8	2700
EX630EAN	1.18	4.5	2500	3.3	9.0	6.1	22.5	14.7	4000
EX820EAR	1.65	8.5	1850	5.8	11.0	7.3	26.6	18.3	3900
EX840EAK	2.22	11.5	1850	6.9	21.0	12.2	51.0	30.6	2600
EX860EAJ	2.60	15.5	1600	7.2	31.0	13.9	75.1	34.8	2100

### 3.2.3. UL 230V

Motor	Rated Power	Rated Torque	Rated Speed	Rated Current	Low Speed Torque	Low speed Current	Peak Torque	Peak Current	Max. Speed
	Pn (kW)	Mn (Nm)	Nn [rpm]	In [Arms]	Mo [Nm]	Io [Arms]	Mpeak [Nm]	I peak [Arms]	Nmax [rpm]
With 40°C ambient temperature									
EX310UAU	0.62	1.4	4200	2.2	1.60	2.5	4.0	6.3	4200
EX420UAI	1.03	2.5	4000	3.3	3	4.2	8.0	10.8	4000
EX430UAG	1.17	3.5	3200	3.9	4.4	4.9	10.0	11.3	3200
EX620UAM	1.37	4.8	2750	4.7	6	6.0	16.0	14.8	2750
EX630UAK	2.01	7.1	2700	6.2	10	7.9	23.7	19.4	2700
EX820UAQ	2.43	10.1	2300	7.2	13	9.1	29.7	22.8	2300
EX840UAL	2.90	16.8	1650	9.0	23	12.0	56.5	32.3	1650
EX860UAJ	3.50	22.3	1500	10.0	31	13.9	78.5	37.1	1500

### 3.2.4. UL 400V

Motor	Rated Power	Rated Torque	Rated Speed	Rated Current	Low Speed Torque	Low speed Current	Peak Torque	Peak Current	Max. Speed
	Pn (kW)	Mn (Nm)	Nn [rpm]	In [Arms]	Mo [Nm]	Io [Arms]	Mpeak [Nm]	I peak [Arms]	Nmax [rpm]
With 40°C ambient temperature									
EX310UAU	0.82	1.0	7600	1.7	1.6	2.5	4.0	6.3	7600
EX420UAI	0.81	1.1	7000	1.6	3.2	4.2	8.0	10.8	7000
EX430UAG	1.02	1.7	5700	2.1	4.4	4.9	10.0	11.3	5700
EX620UAM	1.27	2.8	4300	3.0	6.4	6.0	16.0	14.8	4300
EX630UAK	1.92	4.4	4200	4.0	9.5	7.9	23.7	19.4	4200
EX820UAQ	2.62	7.0	3600	5.1	12.9	9.1	29.7	22.8	3600
EX840UAL	2.08	6.8	2900	3.9	22.6	12.0	56.5	32.3	2900
EX860UAJ	2.18	8.3	2500	4.0	31.4	13.9	78.5	37.1	2500

### 3.2.5. Further Data

Motor	Kt [Nm/Arms]	Ke [Vrms/krpm]	Inductance [mH]	Winding Resistance [ohms]	Moment of Inertia J [kgmm <sup>2</sup> ]	Polarity p [-]	Motor Thermal Time Constant tth [s]
<b>ATEX / IECEx</b>							
EX310EAP	1.42	88.9	62	20.7	79	10	55.9
EX310EAK	0.81	50.9	20.3	6.58	79	10	57.7
EX420EAP	1.42	89	33	7.2	290	10	71
EX420EAJ	0.821	51.4	11	2.31	290	10	73.7
EX430EAL	1.45	90.9	21	4.22	426	10	76.3
EX430EAF	0.828	51.8	6.8	1.38	426	10	75.7
EX620EAV	2.78	180	67.6	7.9	980	10	137
EX620EAR	1.48	95.7	19.2	2.24	980	10	137
EX630EAR	2.27	138	24.9	2.43	1470	10	158
EX630EAN	1.5	91.6	10.9	1.12	1470	10	150
EX820EAR	1.51	93	8.57	1.01	3200	10	137
EX840EAK	1.72	106	5.42	0.493	6200	10	170
EX860EAJ	2.23	140	6.43	0.499	9200	10	209
<b>UL</b>							
EX310UAU	0.652	41	13.2	4.29	79	10	61.8
EX420UAI	0.772	48.3	9.72	1.94	290	10	86
EX430UAG	0.902	56.4	8.07	1.55	426	10	93.1
EX620UAM	1.06	68.8	9.92	1.08	980	10	147
EX630UAK	1.2	73.6	7.06	0.674	1470	10	161
EX820UAQ	1.42	87.2	7.53	0.889	3200	10	154
EX840UAL	1.89	118	6.69	0.579	6200	10	207
EX860UAJ	2.26	140	6.43	0.499	9200	10	242

### 3.2.6. Efficiency curves



Caution: The efficiency curves are typical values. They may vary from one motor to another



Caution: The efficiency curves are given for an optimal motor control (no voltage saturation and optimal phase between current and EMF)



Caution: The efficiency curves do not include the losses due to the switching frequency.



### 3.2.6.1. Series EX310E (EX310EAP)

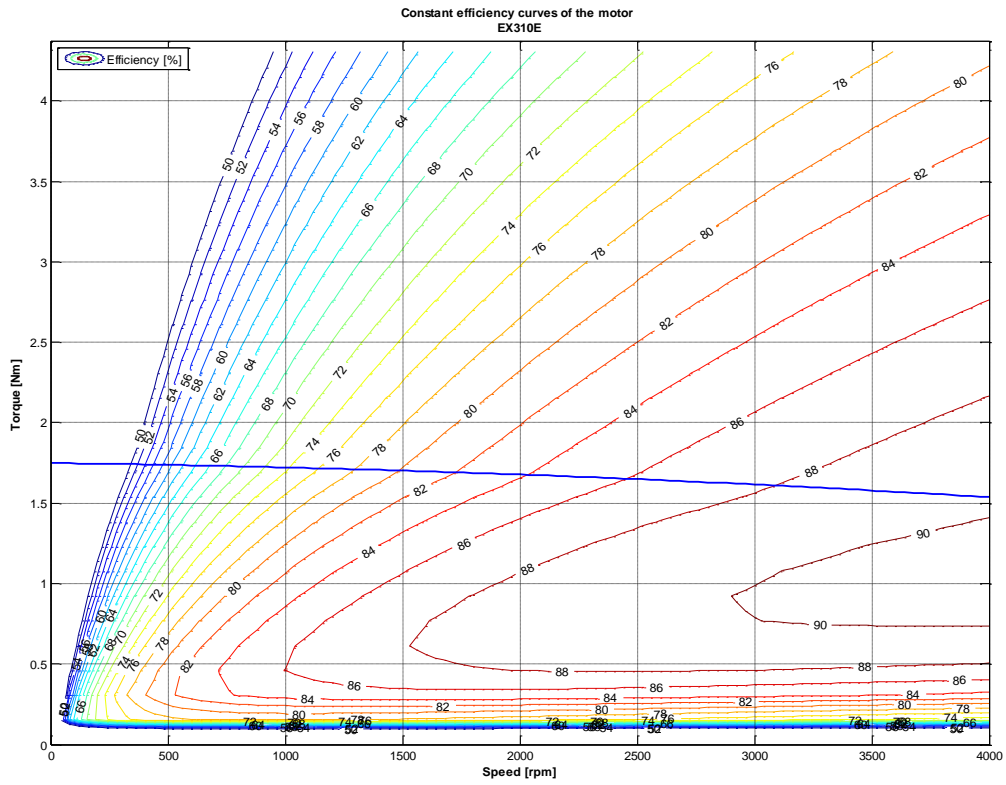

### 3.2.6.2. Series EX420E (EX420EAP)

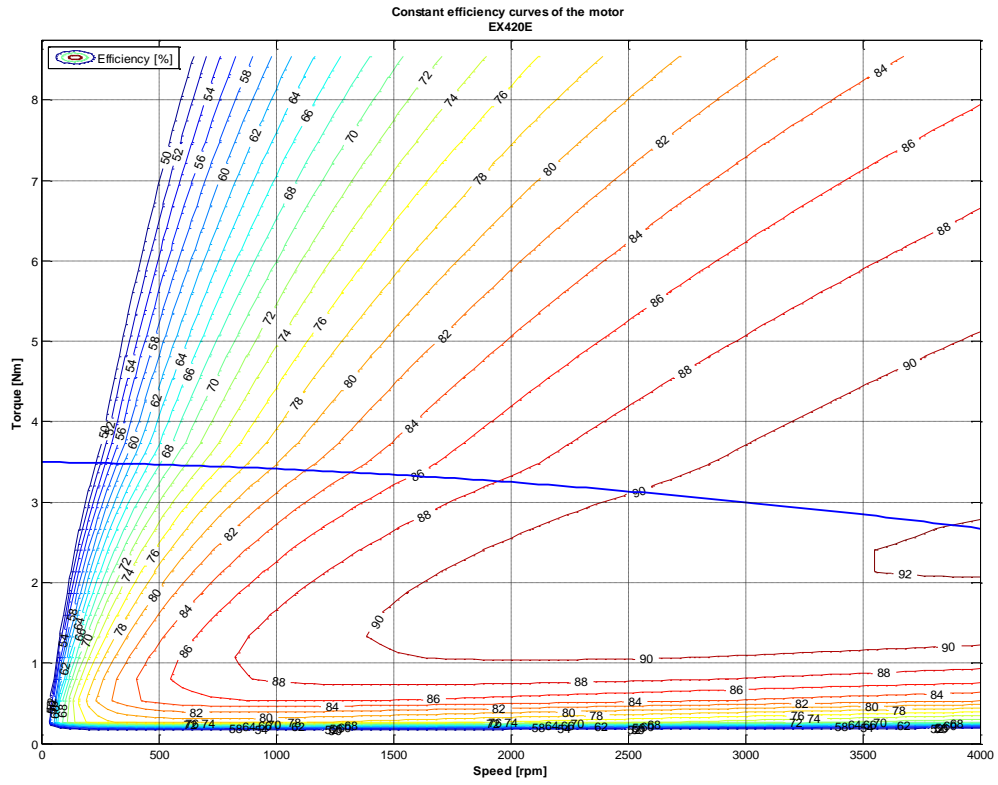

### 3.2.6.3. Series EX430E (EX430EAL)

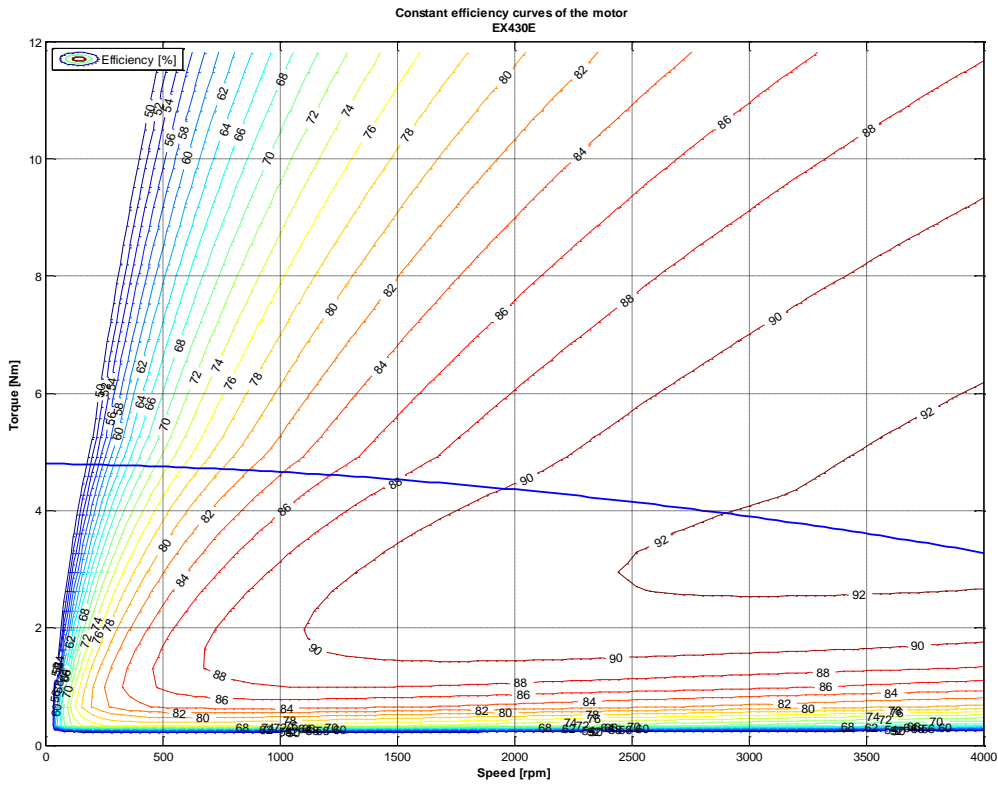



### 3.2.6.4. Series EX620E (EX620EAO)

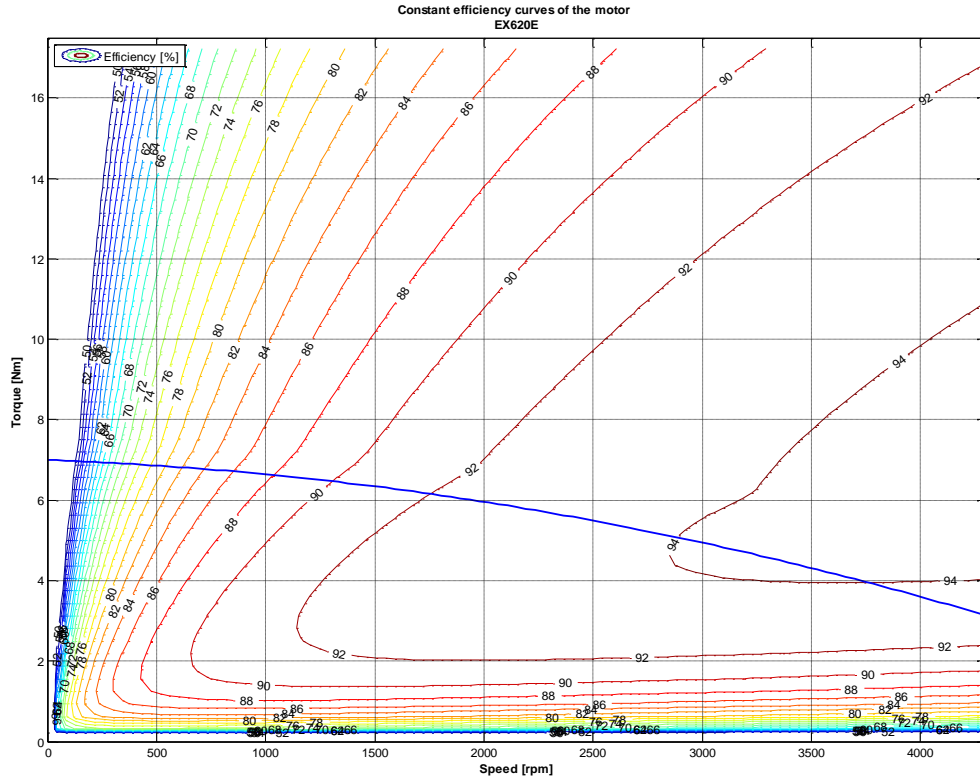

### 3.2.6.5. Series EX630E (EX630EAN)

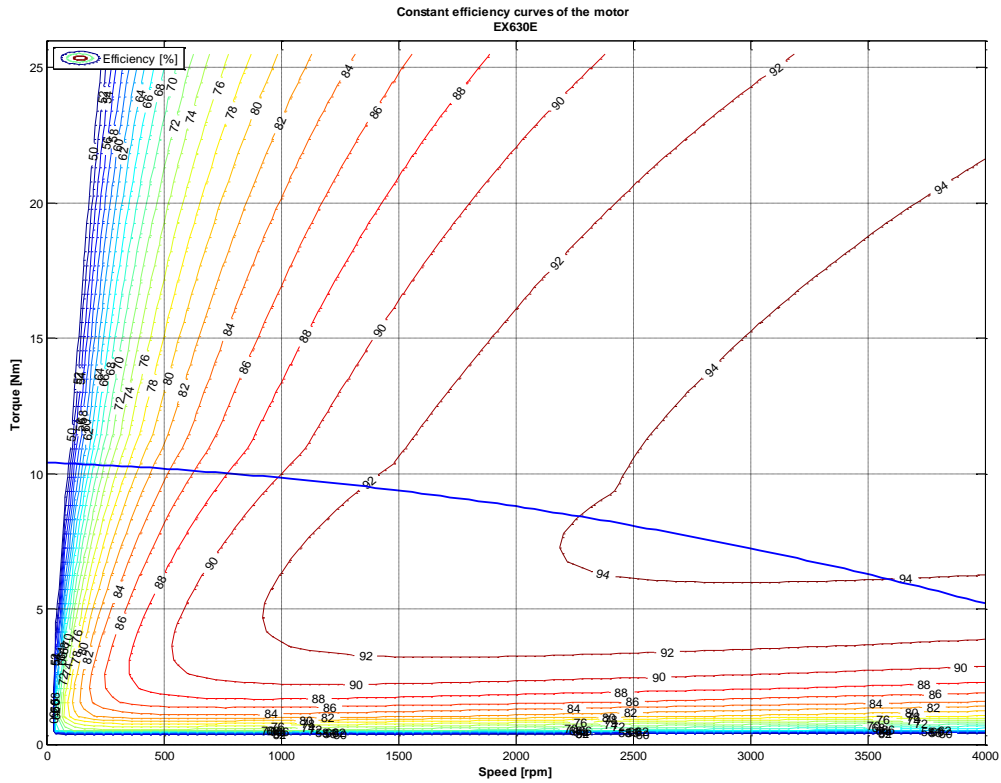

### 3.2.6.6. Series EX820E (EX820EAR)

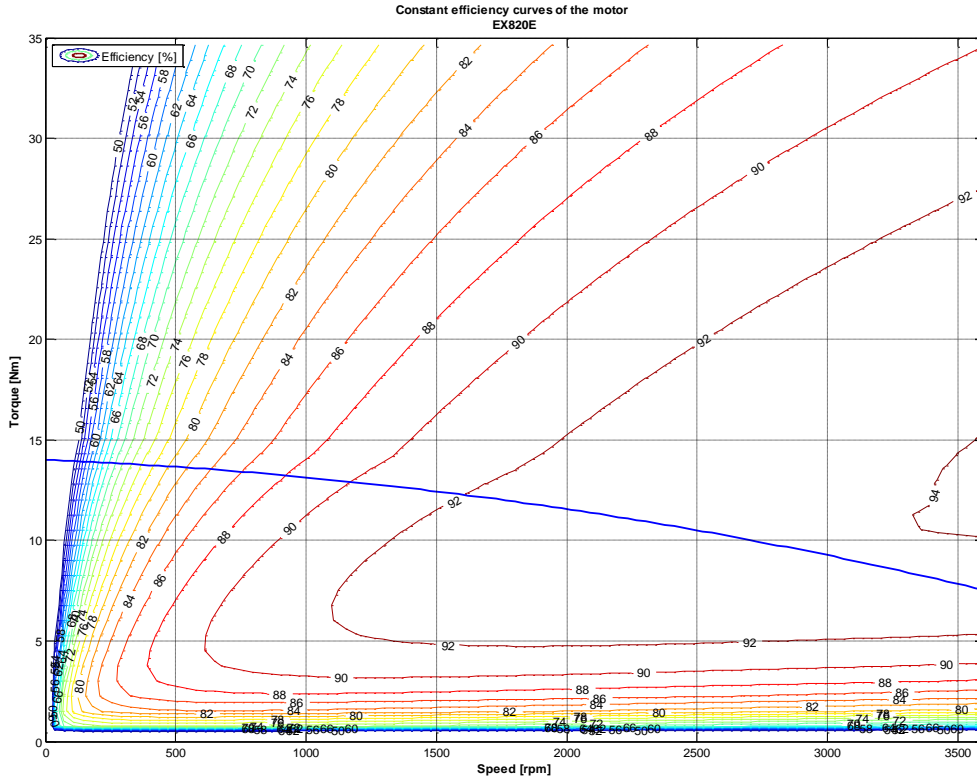

### 3.2.6.7. Series EX840E (EX840EAK)

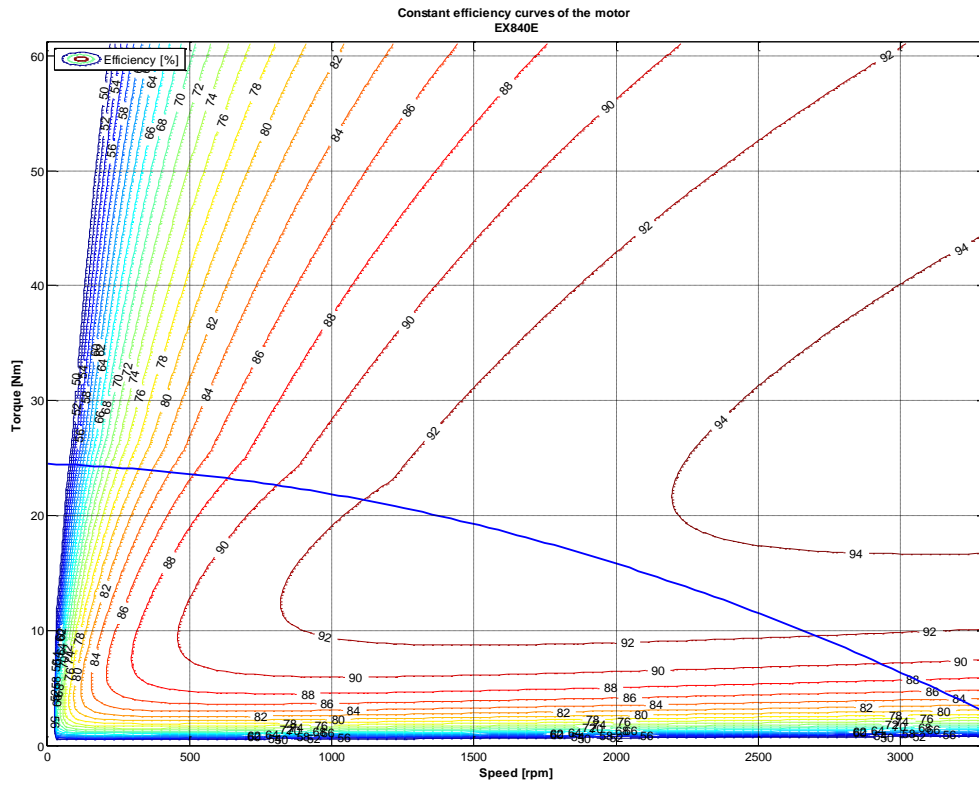



### 3.2.6.8. Series EX860E (EX860EAJ)

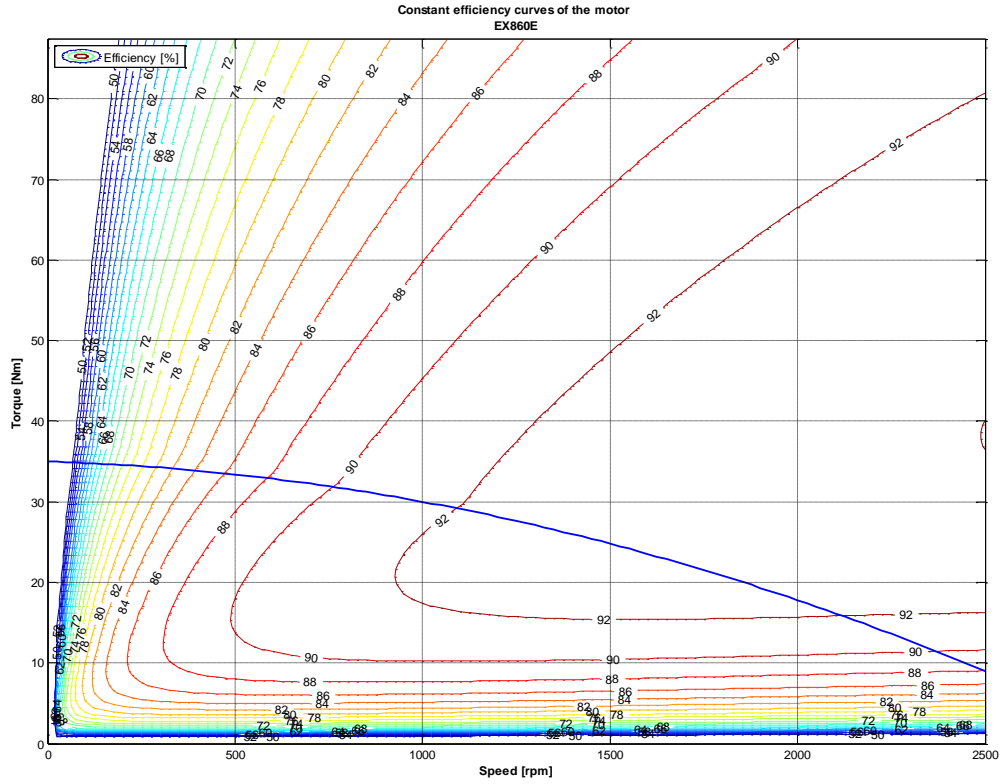

### 3.2.6.9. Series EX310U (EX310UAU)

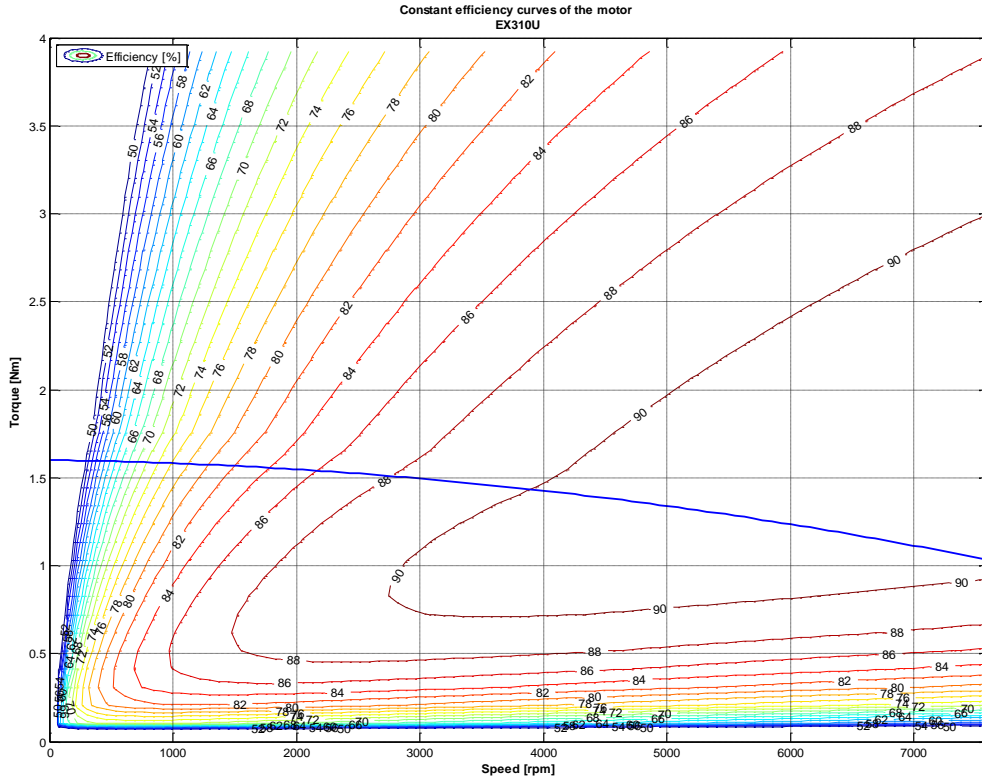

### 3.2.6.10. Series EX420U (EX420UAI)

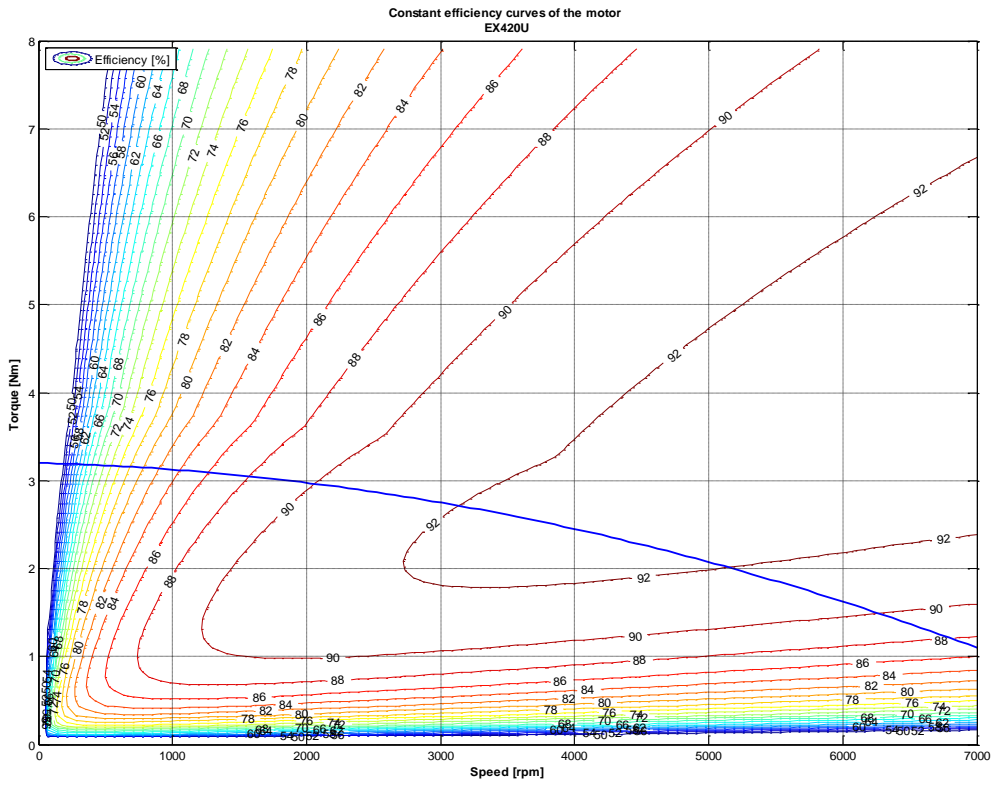

### 3.2.6.11. Series EX430U (EX430UAG)

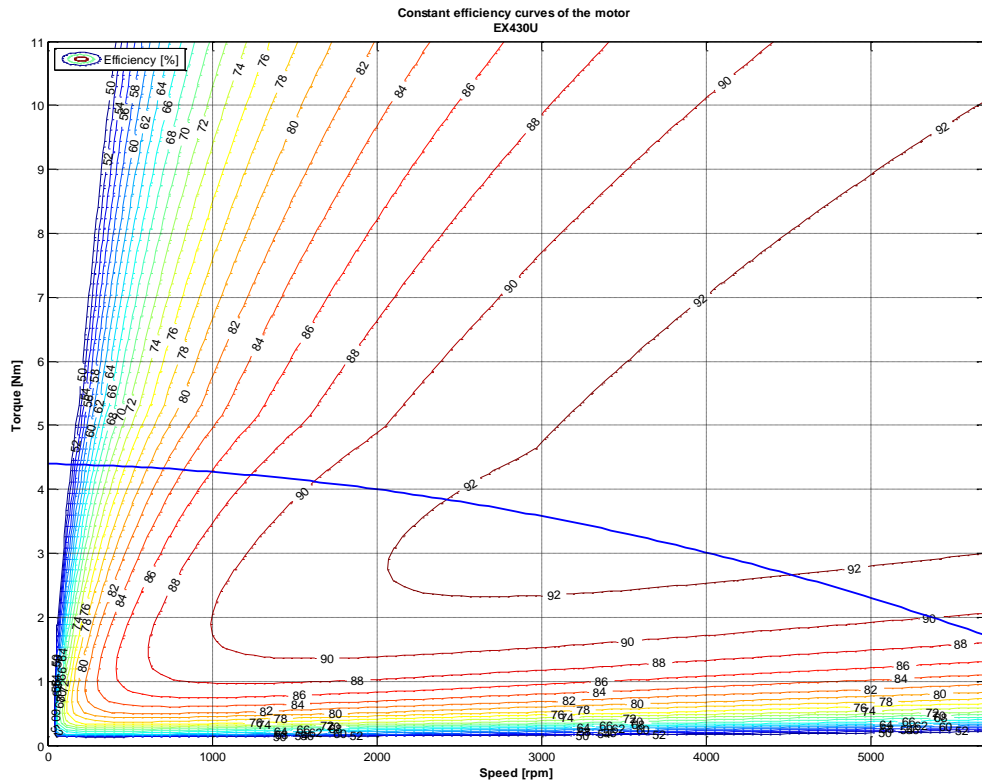

### 3.2.6.12. Series EX620U (EX620UAM)

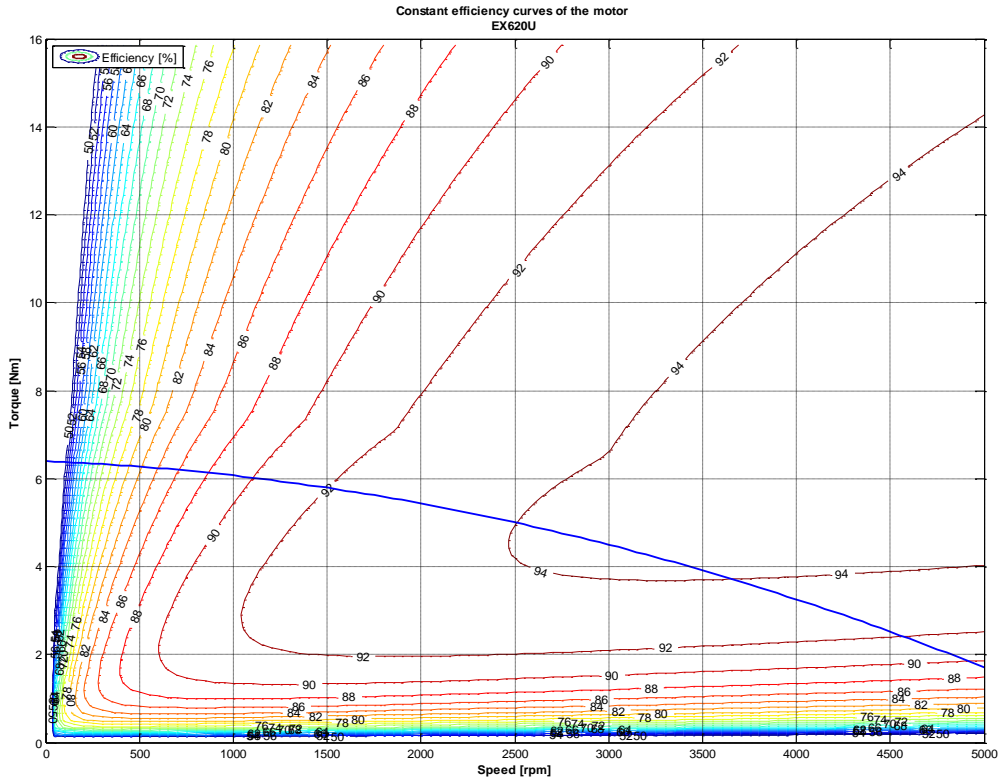

### 3.2.6.13. Series EX630U (EX630UAK)

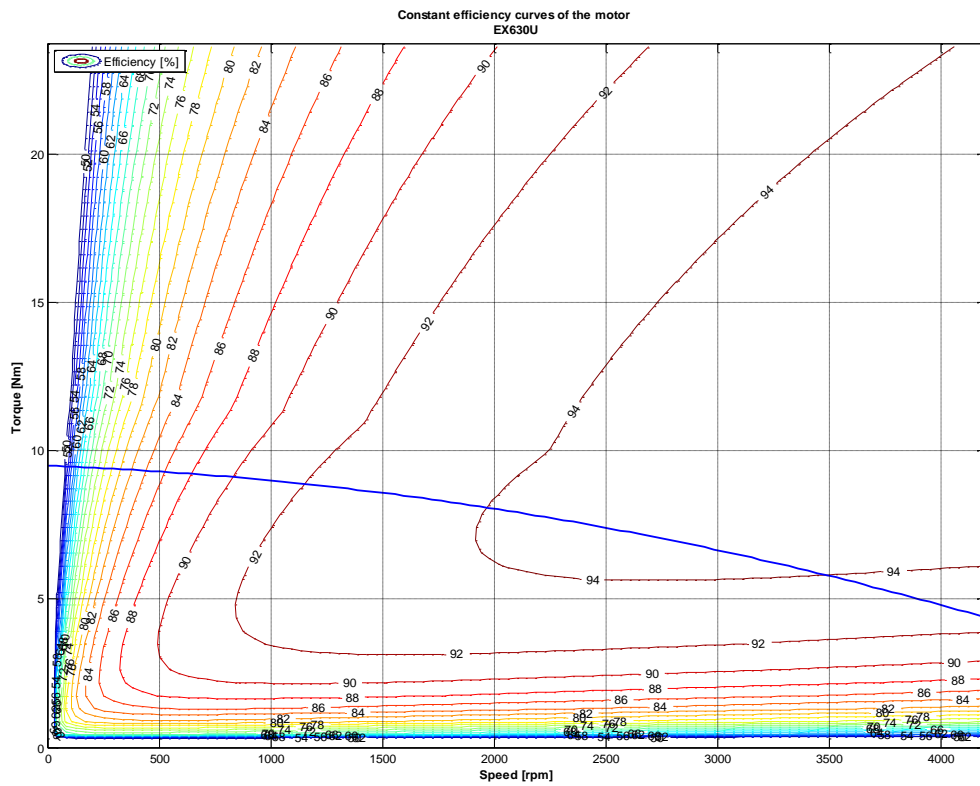

### 3.2.6.14. Series EX820U (EX820UAQ)

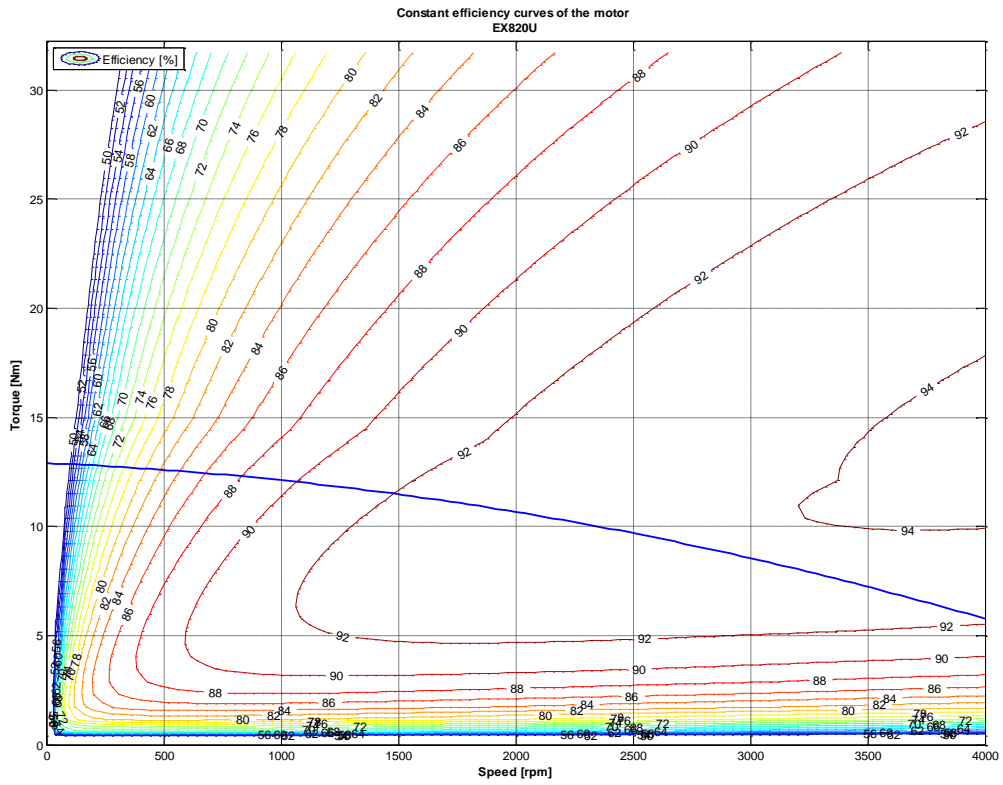

### 3.2.6.15. Series EX840U (EX840UAL)

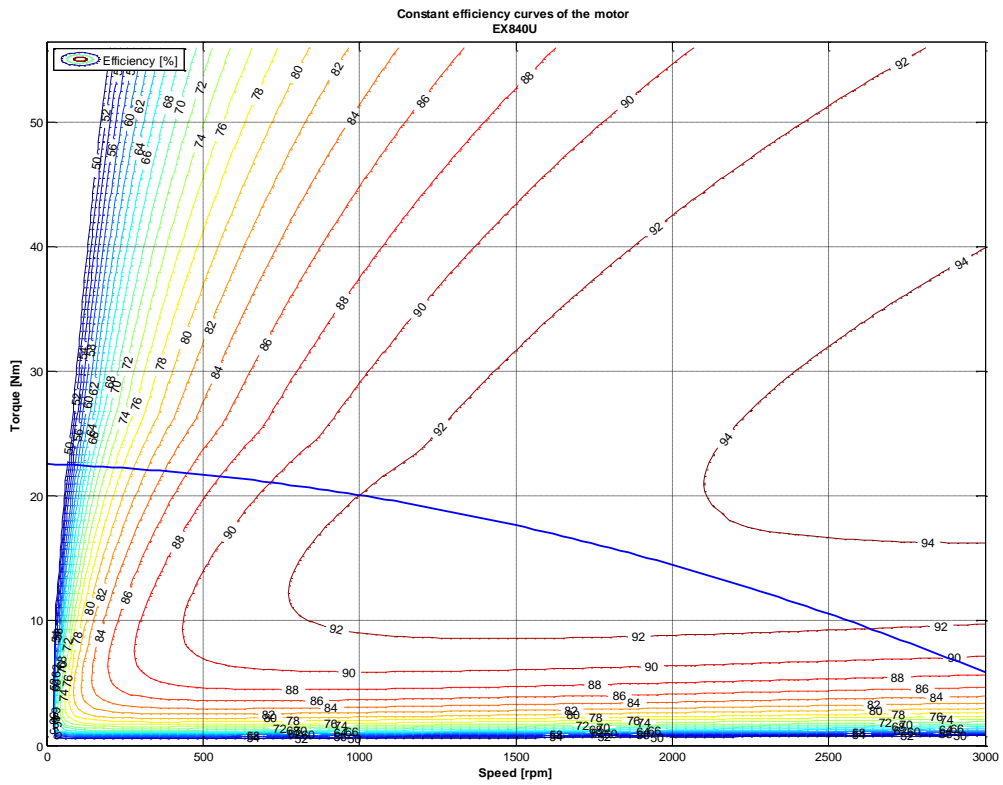

### 3.2.6.16. Series EX860U (EX860UAJ)

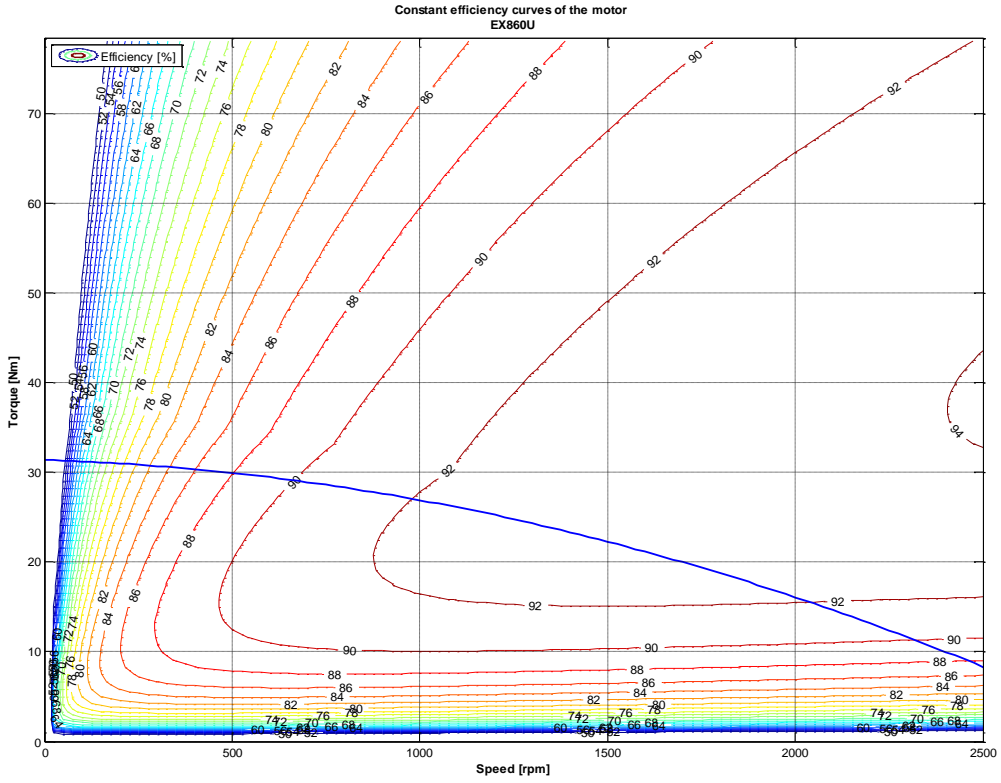



### 3.2.7. Electromagnetic losses



Caution: Following data result from our best estimations but are indicative. They can vary from one motor to another and with temperature. No responsibility will be accepted for direct or indirect losses or damages due to the use of these data.

(Following data are indicative, without lip seal, IP64 motor)

Type	Tf [Nm]	Kd [Nm/1000rpm]
EX310EAP	0.067	0.033
EX420EAP	0.090	0.114
EX430EAP	0.106	0.149
EX620EAR	0.106	0.196
EX630EAR	0.131	0.245
EX820EAR	0.160	0.300
EX840EAK	0.190	0.380
EX860EAJ	0.220	0.460

Torque losses (N.m) = Tf + Kd x speed(rpm)/1000

### 3.2.8. Time constants of the motor

#### 3.2.8.1. Electric time constant:

$$\tau_{elec} = \frac{L_{ph\_ph}}{R_{ph\_ph}}$$

With following values given in the motor data sheet

$L_{ph\_ph}$  inductance of the motor phase to phase [H],

$R_{ph\_ph}$  resistance of the motor phase to phase at 25°C [Ohm].

#### Example:

Motor series EX620EAO

$L_{ph\_ph} = 14 \text{ mH}$  or  $14 \cdot 10^{-3} \text{ H}$

$R_{ph\_ph}$  at 25°C = 1.63 Ohm

→  $\sigma_{elec} = 14 \cdot 10^{-3} / 1.63 = 8.6 \text{ ms}$

An overall summary of motor time constants is given a little further.

#### 3.2.8.2. Mechanical time constant:

$$\tau_{mech} = \frac{R_{ph\_n} * J}{Kt * Ke_{ph\_n}} = \frac{0.5 * R_{ph\_ph} * J}{(3 * \frac{Ke_{ph\_ph}}{\sqrt{3}}) * \frac{Ke_{ph\_ph}}{\sqrt{3}}}$$

$$\tau_{mech} = \frac{0.5 * R_{ph\_ph} * J}{(Ke_{ph\_ph})^2}$$

With following values obtained from the motor data sheet:

$R_{ph\_ph}$  resistance of the motor phase to phase at 25°C [Ohm],

$J$  inertia of the rotor [kgm<sup>2</sup>],

$Ke_{ph\_ph}$  back emf coefficient phase to phase [ $V_{rms}/rad/s$ ].

The coefficient  $Ke_{ph\_ph}$  in the formula above is given in [ $V_{rms}/rad/s$ ]

To calculate this coefficient from the datasheet, use the following relation:

$$Ke_{ph\_ph} [V_{rms}/rad/s] = \frac{Ke_{ph\_ph} [V_{rms}/1000rpm]}{2 * \pi * 1000 / 60}$$

#### Example:

Motor series EX620EAO

$R_{ph\_ph}$  at 25°C = 1.63 Ohm

$J = 98 \cdot 10^{-5} \text{ kgm}^2$

$Ke_{ph\_ph} [V_{rms}/1000rpm] = 81.7 [V_{rms}/1000rpm]$

→  $Ke_{ph\_ph} [V_{rms}/rad/s] = 81.7 / (2 * \pi * 1000 / 60) = 0.7802 [V_{rms}/rad/s]$

→  $\sigma_{mech} = 0.5 * 1.63 * 98 \cdot 10^{-5} / (0.7802^2) = 1.3 \text{ ms}$

**Remarks:**

For a DC motor, the mechanical time constant  $\sigma_{mech}$  represents the duration needed to reach 63% of the final speed when applying a voltage step without any resistant torque. However this value makes sense only if the electric time constant  $\sigma_{elec}$  is much smaller than the mechanical time constant  $\sigma_{mech}$  (for the motor EX620EAO taken as illustration, it is not the case because we obtain  $\sigma_{mech} < \sigma_{elec}$ ).

An overall summary of motor time constants is given a little further.

**3.2.8.3. Thermal time constant of the copper:**

$$\tau_{therm} = Rth * Cth_{copper}$$

$$Cth_{copper [J/^{\circ}K]} = Mass_{copper [Kg]} * 389_{[J/kg^{\circ}K]}$$

With:

- Rth** thermal resistance between copper and ambient temperature [ $^{\circ}K/W$ ]
- Cth<sub>copper</sub>** thermal capacity of the copper [ $J/^{\circ}K$ ]
- Mass<sub>copper</sub>** mass of the copper (winding) [kg]

Hereunder is given an overall summary of motor time constants:

Type	Electric time constant [ms]	Mechanical time constant [ms]	Thermal time constant of copper [s]
EX310	3.0	1.1	60.2
EX420	4.6	1.4	71.0
EX430	5.2	1.1	79.8
EX620	8.6	1.3	137
EX630	10.3	1.0	158
EX820	8.5	2.1	135
EX840	11.0	1.5	171
EX860	12.9	1.3	206

### **3.2.9. Speed ripple**

The typical speed ripple for a EX motor with a resolver at 4000rpm is 3% peak to peak. This value is given as indicative data because depending on the settings of the drive (gains of both speed and current regulation loops, presence of filtering or not, load inertia, resistant torque and type of sensor in use), without external load (neither external inertia nor resistant torque).

### **3.2.10. Cogging torque**

The typical cogging for a EX series below is the maximum value peak to peak in N.cm:

<b>Motor</b>	<b>Cogging Maxi [N.cm]</b>
EX310	2.5
EX420	4.4
EX430	5.7
EX620	5.3
EX630	6.8
EX820	9
EX840	16
EX860	20

### 3.2.11. Rated data according to rated voltage variation

The nominal characteristics and especially the rated speed, maximal speed, rated power, rated torque, depend on the nominal voltage supplying the motor considered as the rated voltage. The rated data mentioned in the data sheet are given for each association of motor and drive. Therefore, if the supply voltage changes, the rated values will also change. As long as the variation of the rated voltage remains limited, for instance to  $\pm 10\%$  of the nominal value, it is possible to correctly evaluate the new rated values as illustrated below.

#### Example:

Extract of Ex630EAI datasheet

BRUSHLESS MOTOR <b>EX630EAI</b> ELECTRONIC DRIVE DRIVE 10/36 Arms 230 Vac		
No UL certification		

Pn	Rated power **	2.27	<i>kW</i>	<b>Cooling type :</b> Natural Air cooling Flange 400*400*12mm(ALU)
Mn	Rated torque **	7.24	<i>Nm</i>	
Nn	Rated speed	3000	<i>rpm</i>	
In	Rated current	6.75	<i>A<sub>rms</sub></i>	
Un	Rated voltage	205	<i>V<sub>rms</sub></i>	
UR	Voltage of the mains	230	<i>V<sub>rms</sub></i>	<b>Environment :</b> Ambient temperature : 40°C MAX Altitude : < 1000 m Thermal class : F (according to IEC 60034-1)
U	DC voltage supply when motor is loaded	310	<i>V</i>	
M <sub>0</sub>	Low speed torque **	10.4	<i>N.m</i>	
I <sub>0</sub>	Permanent current at low speed	9.28	<i>A<sub>rms</sub></i>	
M <sub>p</sub>	Max. torque **	25.9	<i>Nm</i>	
I <sub>p</sub>	Max. current	23.2	<i>A<sub>rms</sub></i>	<b>Efficiency :</b> at rated torque : 94.4 % at 75% of rated torque : 93.9 %
N <sub>p</sub>	Max. speed	3000	<i>rpm</i>	
J	Rotor inertia	0.0015	<i>kg.m<sup>2</sup></i>	
Ke	Back emf constant at 1000 rpm (25°C)*	68.2	<i>V<sub>rms</sub></i>	
Kt	Torque sensitivity (25°C) *	1.12	<i>Nm/A<sub>rms</sub></i>	
Rb	Winding resistance(25°C) *	0.595	<i>Ω</i>	Number of poles : 10
L	Winding inductance *	6.06	<i>mH</i>	

All data are given in typical values under standard conditions

\* Phase to Phase

\*\* General tolerances  $\pm 7.5\%$ , rotor at 25°C

If we suppose that the rated voltage  $U_n=400 V_{rms}$  decreases of **10%** ; this means that the new rated voltage becomes  $U_{n2}=360 V_{rms}$ .

#### Rated speed:

The former rated speed  $N_n=3000 rpm$  obtained with a rated voltage  $U_n=400 V_{rms}$  and an efficiency  $\eta=92\%$  leads to the new rated speed  $N_{n2}$  given as follows:

$$N_{n2} = N_n * \frac{\frac{U_{n2}}{U_n} - 1 + \eta}{\eta}$$

$$N_{n2} = 3000 * \frac{\frac{360}{400} - 1 + 0.92}{0.92} = 2674 rpm$$

### Maximum speed:

The former maximum speed  $N_{\max} = 3000$  rpm obtained with  $U_n = 400$  V<sub>rms</sub> and a speed  $N_n = 3000$  rpm leads to the new maximum speed  $N_{\max 2}$  given as follows:

$$N_{\max 2} = N_{\max} * \frac{N_{n2}}{N_n} \qquad N_{\max 2} = 3000 * \frac{2674}{3000} = 2674 \text{rpm}$$

### N.B.

If the rated voltage increases ( $U_{n2} > U_n$ ), the new rated speed  $N_{n2}$  and the new maximum speed  $N_{\max 2}$  will be greater than the former ones  $N_n$  and  $N_{\max}$ . Moreover you will have to check that the drive still shows able to deal with the new maximum electric frequency.

	<p><u>Warning:</u> If the main supply decreases, you must reduce the maximum speed accordingly in order to do not damage the motor. In case of doubt, consult us.</p>
---	---

### Rated power:

The former rated power  $P_n = 2270$  W obtained with  $U_n = 400$  V<sub>rms</sub> leads to the new rated power  $P_{n2}$  given as follows:

$$P_{n2} = P_n * \frac{U_{n2}}{U_n} \qquad P_{n2} = 2270 * \frac{360}{400} = 2043 \text{W}$$

### Rated torque:

The former rated torque  $M_n = 7.24$  Nm obtained with  $U_n = 400$  V<sub>rms</sub> leads to the new rated torque  $M_{n2}$  given as follows:

$$M_{n2} = \frac{P_{n2}}{\frac{2 * \pi * N_{n2}}{60}} \qquad M_{n2} = \frac{2043}{\frac{2 * \pi * 2674}{60}} = 7.3 \text{Nm}$$

### 3.2.12. Voltage withstand characteristics of EX series

The motors fed by converters are subject to higher stresses than in case of sinusoidal power supply. The combination of fast switching inverters with cables will cause overvoltage due to the transmission line effects. The peak voltage is determined by the voltage supply, the length of the cables and the voltage rise time. As an example, with a rise time of 200 ns and a 30 m (100 ft) cable, the voltage at the motor terminals is twice the inverter voltage. The insulation system of the servomotors EX is designed to withstand high repetitive pulse voltages and largely exceeds the recommendations of the IEC/TS 60034-25 ed 2.0 2007-03-12 for motors without filters up to 500V AC (See figure 1).

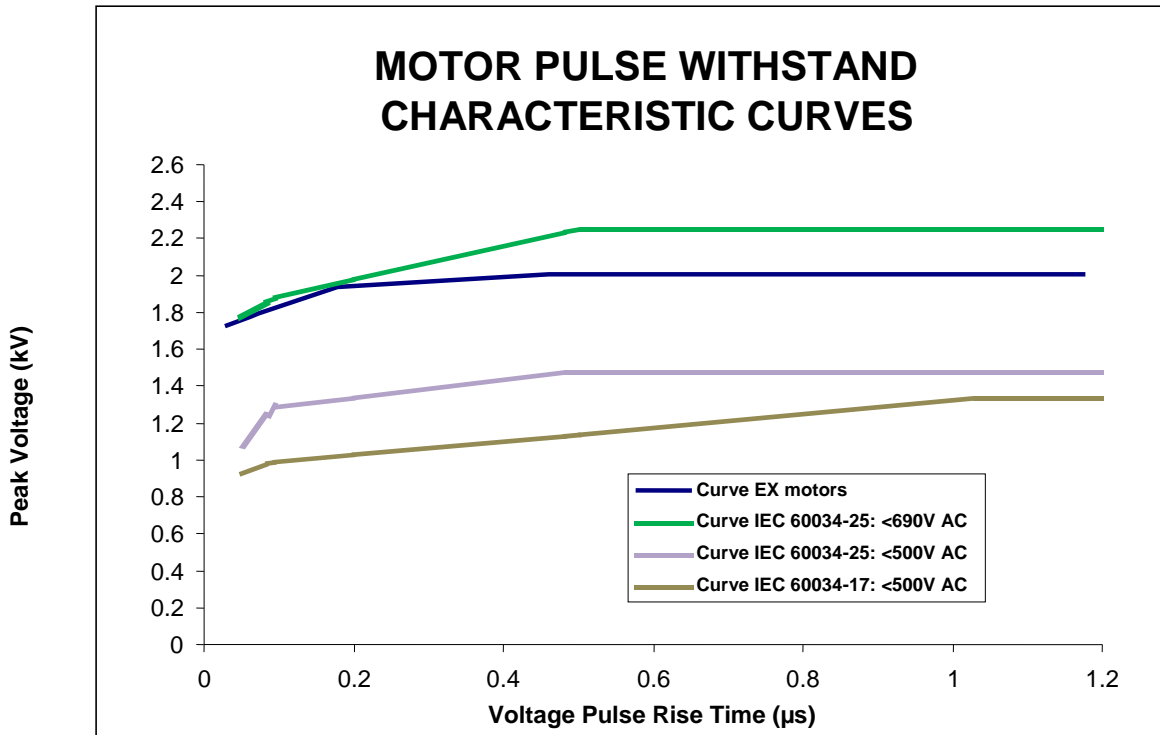

Figure 1: Minimum Voltage withstands characteristics for motors insulations according to IEC standards. At the top are the typical capabilities for the EX motors.

Note: The pulse rise times are defined in accordance with the IEC/TS 60034-17 ed4.0 2006-05-09.

The EX motors can be used with a supply voltage up to 480 V under the following conditions:

- The pulse rise times must be longer than 50 ns.
- The repetitive pulse voltages must not exceed the values given in figure 1, “*Curve EX motors*” in dark blue.

### **3.2.13. Voltage and current during the operating**

The EX motors carry ATEX and UL certification and due to this certificate, they are subjected to strict rules regarding their use. One of such rules is the use of a servoamplifier that meets specific characteristics.

#### **EX310 ATEX :**

<b>Voltage of the associated speed drive</b>	<b>24V direct current</b>	<b>48V direct current</b>	<b>230V single / three phase</b>	<b>400V three phase</b>
Power supply direct current voltage (V)	24 ±10%	48 ±10%	310 ±10%	550 ±10%
Motor electrical frequency (Hz)	0 to 700	0 to 700	0 to 700	0 to 700
Steady peak current in a phase (Â/Arms)	Max. 17/12	Max. 17/12	Max. 7.5/5.3	Max. 4/2.8
Maximum peak current in a phase (Â/Arms)	Max. 34/24	Max. 34/24	Max. 15/10.6	Max. 8/5.6
Maximum steady motor power (W)	Max. 250	Max. 500	Max. 1900	Max. 1800

#### **EX4 ATEX :**

<b>Voltage of the associated speed drive</b>	<b>24V direct current</b>	<b>48V direct current</b>	<b>230V single / three phase</b>	<b>400V three phase</b>
Power supply direct current voltage (V)	24 ±10%	48 ±10%	310 ±10%	550 ±10%
Motor electrical frequency (Hz)	0 to 600	0 to 600	0 to 600	0 to 600
Steady peak current in a phase (Â/Arms)	Max. 17/12	Max. 17/12	Max. 14/9.9	Max. 8/5.6
Maximum peak current in a phase (Â/Arms)	Max. 34/24	Max. 34/24	Max. 28/19.8	Max. 16/11.3
Maximum steady motor power (W)	Max. 200	Max. 400	Max. 3400	Max. 3400

#### **EX6 ATEX :**

<b>Voltage of the associated speed drive</b>	<b>230V single / three phase</b>	<b>400V three phase</b>
Power supply direct current voltage (V)	310 ±10%	550 ±10%
Motor electrical frequency (Hz)	0 to 500	0 to 500
Steady peak current in a phase (Â/Arms)	Max. 25/17.7	Max. 16/11.3
Maximum peak current in a phase (Â/Arms)	Max. 50/35.3	Max. 32/22.6
Maximum steady motor power (W)	Max. 6000	Max. 6000

#### **EX8 ATEX :**

<b>Voltage of the associated speed drive</b>	<b>230V single / three phase</b>	<b>400V three phase</b>
Power supply direct current voltage (V)	310 ±10%	550 ±10%
Motor electrical frequency (Hz)	0 to 500	0 to 500
Steady peak current in a phase (Â/Arms)	Max 100/70.7	Max 50/35.3
Maximum peak current in a phase (Â/Arms)	Max 200/141.4	Max 100/70.7
Maximum steady motor power (W)	Max 10 000	Max 10 000



**EX310 UL :**

Voltage of the associated speed drive	230V single / three phases	400-480V three phases
Nominal Power supply direct current voltage(v)	310 ±10%	550-660 ±10%
Motor electrical frequency (Hz)	0 to 650	0 to 650
Steady peak current in a phase (Â/Arms)	Max. 7.5/5.3	Max. 4/2.8
Maximum peak current in a phase (Â/Arms)	Max. 15/10.6	Max. 8/5.6
Maximum steady motor power (W)	Max. 1900	Max. 1800

**EX4 UL :**

Voltage of the associated speed drive	230V single / three phases	400-480V three phases
Nominal Power supply direct current voltage (V)	310 ±10%	550-660 ±10%
Motor electrical frequency (Hz)	0 to 650	0 to 650
Steady peak current in a phase (Â/Arms)	Max. 14/9.9	Max. 8/5.6
Maximum peak current in a phase (Â/Arms)	Max. 28/19.8	Max. 16/11.3
Maximum steady motor power (W)	Max. 3400	Max. 3400

**EX6 UL :**

Voltage of the associated speed drive	230V single / three phases	400- 480V three phases
Nominal Power supply direct current voltage (V)	310 ±10%	550-660 ±10%
Motor electrical frequency (Hz)	0 to 650	0 to 650
Steady peak current in a phase (Â)	Max. 25	Max. 16
Maximum peak current in a phase (Â)	Max. 50	Max. 32
Maximum steady motor power (W)	Max. 6000	Max. 6000

**EX8 UL :**

Voltage of the associated speed drive	230V single / three phases	400-480V three phases
Nominal Power supply direct current voltage (V)	310 ±10%	550-660 ±10%
Motor electrical frequency (Hz)	0 to 500	0 to 500
Steady peak current in a phase (Â)	Max 100	Max 50
Maximum peak current in a phase (Â)	Max 200	Max 100
Maximum steady motor power (W)	Max 10 000	Max 10 000



Warning : EX motors must be connected in accordance with the diagrams given in chapter §4.3.3



### 3.3.2. EX420E EX430E

<b>IP Motor</b>	IP64	IP65	
<b>Protection</b>	II 2 G Ex db IIB T4 Gb IP64	II 2 Gb Ex db IIB T4 Gb IP65 Ex tb IIIC T135°C Db IP65	
	<ul style="list-style-type: none"> <li>IEC/EN 60079-0</li> <li>Exes: 0: Equipment</li> <li>Part 0: Equipment</li> <li>General requirements.</li> </ul>	<ul style="list-style-type: none"> <li>IEC/EN 60079-0</li> <li>Exes: 0: Equipment</li> <li>Part 0: Equipment</li> <li>General requirements.</li> </ul>	
	<ul style="list-style-type: none"> <li>IEC/EN 60079-1</li> <li>Part 1: Flameproof protection by flameproof enclosures "d".</li> </ul>	<ul style="list-style-type: none"> <li>IEC/EN 60079-1</li> <li>Part 1: Flameproof protection by flameproof enclosures "d".</li> </ul>	
	<ul style="list-style-type: none"> <li>IEC/EN 60079-31</li> <li>Explosive atmospheres: protection by enclosure "1".</li> </ul>	<ul style="list-style-type: none"> <li>IEC/EN 60079-31</li> <li>Explosive atmospheres: protection by enclosure "1".</li> </ul>	

<b>BRAKE</b>	<b>W.EIGHT</b>	<b>SHAFT END</b>
Supply voltage : 24V	Motor Without brake with brake	M6 x 16
Static torque	EX420 7 Kg 6 Kg	Ø 16
	EX430 5.5 N.m 4 N.m	21.5-8.9
	EX430 4 N.m 4 N.m	4.0±0.6
		32
		4.0±0.6

**EX4 E R1**

- Torque range (depends on length)
- Winding (depends on speed)
- Feedback (depends on length)
- Brake
- IP

A : Resolver - ratio 0.5  
 G : Resolver - ratio 0.3  
 R : Hiperface singleturn SKS36  
 S : Hiperface multiturn SKM36  
 T : Hiperface singleturn SR550  
 U : Hiperface multiturn SRM50  
 X : Low cost encoder  
 Y : Sensorless

**CONNECTIONS VARIANTS ON SHEET 2/2**

<b>Masse :</b>	29/07/09	SD	Vise	
	C AM 24229 03/12/13 AH			
	B AM 24108 22/04/13 SD			
	A AM 23304 10/12/09 SD			
	D AM 24578 22/07/16 SD			

**EX400**

**OUTLINE DRAWING**

344619

**Parker**

4, Bd Eiffel - CS 40090  
21604 LONJVIC CEDEX

Etchelle 1:2

Sheet : 1/2

Format A3

F E S G I

### 3.3.3. EX620E EX630E

Ground screw M5

4 x Ø8.4 on Ø130

Ø150

Ø107

24

Ø110 /6

Ø95

Ø130

120

30°

30°

14

50±0.6

3.5

L Max

IP Motor	IP64	IP65
Protection	II 2 G Ex db IIB T4 Gp IP64	II 2 Gd Ex db IIB T4 Gp IP65 Ex tb IIIC TBS5C Db IP65
	<ul style="list-style-type: none"> <li>IEC/EN 60079-0 : Explosive atmospheres. Part 0 - Equipment. General requirements.</li> <li>IEC/EN 60079-1 : Explosive atmospheres. Part 1 - Protection by flameproof enclosures "d".</li> </ul>	<ul style="list-style-type: none"> <li>IEC/EN 60079-0 : Explosive atmospheres. Part 0 - Equipment. General requirements.</li> <li>IEC/EN 60079-1 : Explosive atmospheres. Part 1 - Protection by flameproof enclosures "d".</li> <li>IEC/EN 60079-31 : Explosive atmospheres. Part 31 - Equipment dust ignition protection by enclosure "t".</li> </ul>

Certification : INERIS 04ATEX0032X  
INE 15.0060X

BRAKE	
Supply voltage : 24V	±10%
Static torque	
EX620	EX630
20 °C	12 N.m
100 °C	8 N.m

WEIGHT	
Motor w/ thout brake	11 Kg
Motor w/ thout brake w/ th brake	13.5 Kg

**WIDTH KEY**

5

4.0

24

27.8±0.2

h9

**SHAFT END**

24

4.0

110

**EX6 ER1**

Torque range (depends on length)  $\frac{w}{loading}$  (depends on speed)

Feedback

0 : IP64  
1 : IP65

Brake

2 : w/ thout brake  
5 : w/ th brake

Shaft

0 : Plain shaft  
1 : W/ th key

A : Resolver - ratio 0.5  
G : Resolver - ratio 0.3  
R : Bipolarite singtelum SKS36  
S : Bipolarite multitelum SKS50  
U : Bipolarite singtelum SKS30  
V : Bipolarite multitelum SKS50  
W : Encod multitelum EDN 1113  
X : Encod multitelum EDN 1125  
Y : Sensorless

**DIMENSIONS**

Feedback options (Feedback letter)	Resolver ratio 0.5 (A) / ratio 0.3 (G)	Resolver	Low cost encoder (A)	Sensorless (T)	Hiperface SKS36 (R)	Hiperface SKS50 (S)	Hiperface SKS50 (T)	Hiperface SKS50 (U)	Encod multitelum EDN 1125 (W)
W/ thout brake	L (mm)	275	300	300	305	310	325	350	375
W/ th brake	L (mm)	300	300	300	310	330	350	350	375
W/ thout brake	L (mm)	300	300	300	330	350	375	375	375
W/ th brake	L (mm)	325	325	325	335	355	375	375	375

CONNECTIONS VARIANTS ON SHEET 2/2

Masse :

General tolerances  
DIN ISO 2768 mK

07/10/09 SD V/ise

AM 24229 03/12/13 AH

AM 24108 22/04/13 SD

AM 23304 10/12/09 SD

D AM 24578 22/07/16 SD

Sheet : 1/2

Format A3

EX600

OUTLINE DRAWING

344550

D

### 3.3.4. EX820E EX840E EX860E

**Power cable gland Exd IIB Ex tD :**  
 Ø8.5-Ø16 + clamping module  
**Sensor cable gland Exd IIB Ex tD :**  
 Ø8.5-Ø16 + clamping module  
 Ground screw M6

**WELT KEY**  
 Lifting eye bolt Ø20

**SHAFT END**  
 M12 x 28  
 10h9  
 35.8<sub>±0.03</sub>

**WEIGHT**

Motor without brake	with brake
EX820	EX820
EX840	EX840
EX860	EX860

**BRAKE**  
 Supply voltage : 24V  
 Static torque

Temperature	EX820	EX840	EX860
20°C	36 Nm	36 Nm	36 Nm
100°C	32 Nm	32 Nm	32 Nm

**IP Motor**  
 II 2 G Ex d II B T4 IP64  
 II 2 GD Ex d II B T4 IP65  
 Ex ID A21 IP65 T135°C

**Protection**  
 • EN 60079-0 : Electrical apparatus for explosive gas atmospheres - Part 0 : General requirements.  
 • EN 60079-1 : Electrical apparatus for explosive gas atmospheres - Part 1 : Flameproof enclosures "d".  
 • EN 61241-0 : Electrical apparatus for use in the presence of combustible dust - Part 0 : General requirements.  
 • EN 61241-1 : Electrical apparatus for use in the presence of combustible dust - Part 1 : Protection by enclosures "IP".

**Standards**  
 Certification :  
 INERIS OSATEX0061X

**EX820E R1**

**Torque range** (depends on length)  
 Winding (depends on speed)  
 IP  
 0 : IP64  
 1 : IP65

**Feedback**  
 Feedback ratio 0.5  
 A : Resolver - ratio 0.5  
 G : Resolver - ratio 0.3  
 R : Hiperface singleturn SKM36  
 S : Hiperface multiturn SKM36  
 T : Hiperface singleturn SPS50  
 U : Hiperface multiturn SPS50  
 V : Endat singleturn EGN 1113  
 W : Endat multiturn EGN 1125  
 X : Low cost encoder  
 Y : Sensorless

**CONNECTIONS VARIANT ON SHEET 2/2**

**Dimensions**

Feedback option	Resolver ratio 0.5 (A)	Low cost encoder (X)	Sensorless (Y)	Hiperface SKS (R)	Hiperface SKM36 (S)	Hiperface SRM50 (T)	Endat EGN 1125 (W)
without brake	290	290	290	310	310	325	325
with brake	325	325	325	345	345	360	360
without brake	350	350	350	370	370	385	385
with brake	385	385	385	405	405	420	420
without brake	410	410	410	430	430	445	445
with brake	445	445	445	465	465	480	480

**General tolerances**  
 DIN ISO 2768 mK

**Drawn** 14/09/09  
**Scale** 2:5  
**Revision** B AM 24.108 22/04/13 SD  
 A AM23304 - 10/12/09 SD

**Format** A3  
**Sheet** 1/2

**EX800**  
**OUTLINE DRAWING**  
 344664  
 B

**Parker**  
 8, Avenue du Dr. BEZIG  
 21007-DIJON cedex-FRANCE  
 www.ssdprives.com

This document is the property of PARKEX. Transmission as well as reproduction or copy is not permitted without written authorisation.

**3.3.5. EX310U**

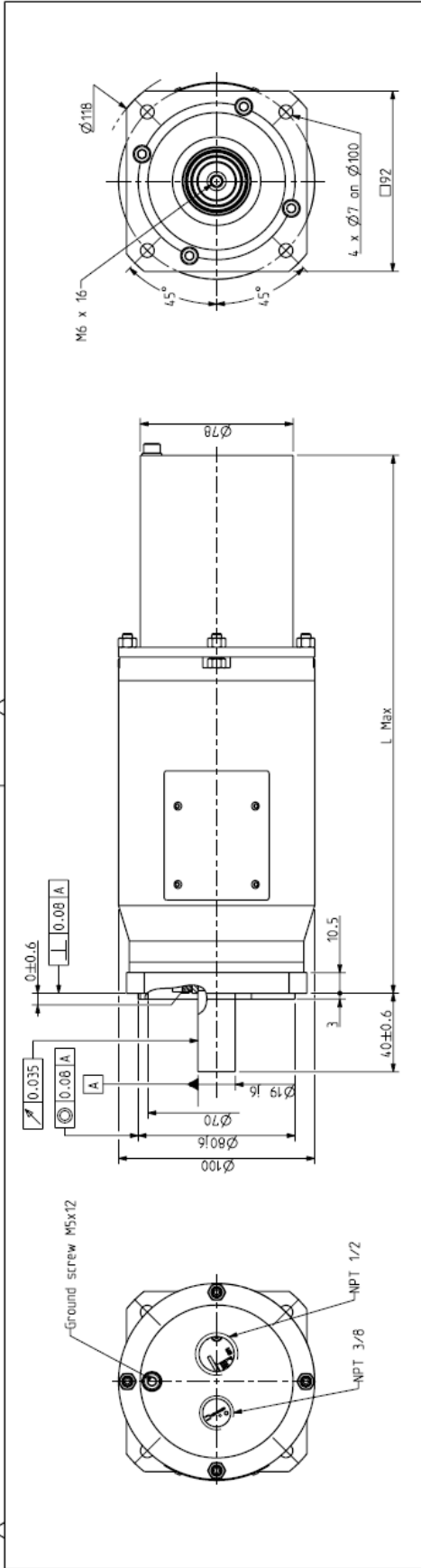

**W/TH KEY**

**SHAFT END**

SAFETY US-CA E302760

Class 1, Division 1, Group C & D  
UL674 : Electric Motors and Generators  
for use in Division 1 Hazardous  
(classified) Locations.

**WEIGHT**

Motor	W/ithout brake	W/ith brake
EX420	7 kg	8 kg
EX430	8 kg	9 kg

**BRAKE**

Supply voltage : 24V --- ±10%

Static torque

Temp	EX420	EX430
20°C	5.5 Nm	5.5 Nm
100°C	4 Nm	4 Nm

**EX400 R1**

Feedback option (feedback letter)	Resolver ratio 0.5 (A)	Low cost encoder (X)	Senseless (Y)	Hyperface SKS36 (R)	Hyperface SKS36 (S)	Hyperface SR550 (T)	Hyperface SR550 (U)	Endat ECN 1113 (V)	Endat EDN 1125 (W)	Torque range (depends on length)		Winding (depends on speed)		ID	
										W/ithout brake	W/ith brake	W/ithout brake	W/ith brake	0 : Plain shaft	1 : W/ith key
EX420				290	315	310	310	310	310	A : Resolver - ratio 0.5	A : Resolver - ratio 0.5	2 : W/ithout brake	0 : Plain shaft	0 : Plain shaft	0 : Plain shaft
				315	315	335	335	335	335	R : Hyperface singtelum SKS36	R : Hyperface singtelum SKS36	5 : W/ith brake	1 : W/ith key	1 : W/ith key	1 : W/ith key
				315	315	335	335	335	335	S : Hyperface multilum SRP36	S : Hyperface multilum SRP36				
				340	340	360	360	360	360	T : Hyperface singtelum SR550	T : Hyperface singtelum SR550				
										U : Hyperface multilum SR550	U : Hyperface multilum SR550				
										V : Endat singtelum ECN 1113	V : Endat singtelum ECN 1113				
										W : Endat multilum EDN 1125	W : Endat multilum EDN 1125				
										X : Low cost encoder	X : Low cost encoder				
										Y : Senseless	Y : Senseless				

**CONNECTIONS VARIANTS ON SHEET 2/2**

Sheet : 1 / 2

	EX400U	Format	F E S G I
	OUTLINE DRAWING	A3	x
		344852	

8 Avenue du Lac, BP249  
21007-010N CEDEX-FRANCE  
www.parker.com

Scale 1:2

Drawn	02/10/09	00	V/isa
General tolerances	C AM 24574 08/07/16 SD		
DIN ISO 2768 mK	B AM 24229 03/12/13 AH		
	A AM 23321 18/01/10 OD		

This document is the property of PARKER. Transmission as well as reproduction or copy is not permitted without written authorisation.

**3.3.6. EX420U EX430U**

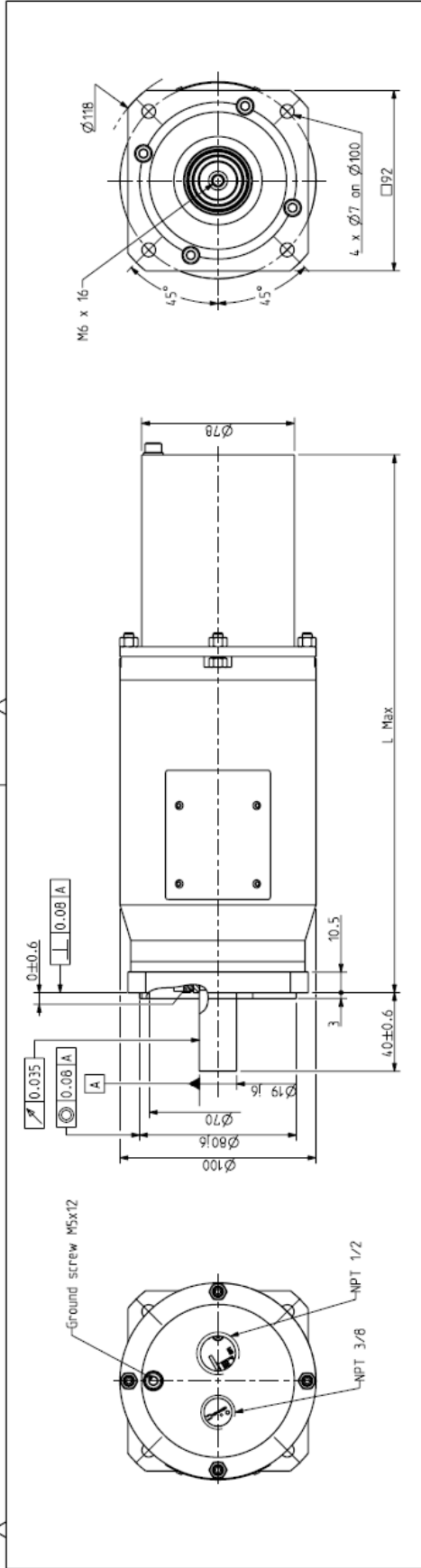

**UL CERTIFIED**  
SAFETY US-CA E302760

Class 1, Division 1, Group C & D  
UL674 : Electric Motors and Generators  
for use in Division 1 Hazardous  
(classified) Locations.

**BRAKE**  
Supply voltage : 24V  
Static torque

	EX420	EX430
20 °C	5.5 Nm	5.5 Nm
100 °C	4 Nm	4 Nm

**WEIGHT**

Motor w/ without brake	w/ with brake
EX420	EX430
7 kg	8 kg
8 kg	9 kg

**SHAFT END**

**EX420U R1**

Feedback option (feedback letter)	Resolver ratio 0.5 (A)	Low cost encoder (X)	Senseless (Y)	Hyperface SK536 (R)	Hyperface SK506 (S)	Hyperface SR550 (T)	Hyperface SR550 (U)	Encoder ECN 1113 (V)	Encoder EDN 1125 (W)	Torque Range (depends on length)		Winding (depends on speed)		Feedbacks	
										L (mm)	L (mm)	0	1	0	1
EX420				290	315	310	335	310	335	310	335	0	1	0	1
EX430				340	315	335	335	360	360	340	360	0	1	0	1

**CONNECTIONS VARIANTS ON SHEET 2/2**

Sheet : 1 / 2

<b>Parker</b>	EX400U	Format A3	F E S G I
8 Avenue du lac BP269 21007-010N COGNAC-FRANCE www.parker.com		OUTLINE DRAWING 344852 C	

### 3.3.7. EX620U EX630U

Class 1, Division 1, Group C & D  
UL674 : Electric Motors and Generators  
for use in Division 1 Hazardous  
(classified) Locations.

**EX60UR1**

Torque range (depends on length)    Winding 1 (depends on speed)    Brake

Feedback    Shaft

A : Resolver - ratio 0.5    2 : without brake  
R : HIPERFACE singleturn SKS36    5 : with brake  
S : HIPERFACE multiturn SKM36  
T : HIPERFACE singleturn SRSS50  
U : HIPERFACE multiturn SRM50  
V : ENDAT singleturn ECN 1113  
W : ENDAT multiturn EQN 1125  
X : Low cost encoder  
Y : Sensorless

CONNECTIONS VARIANTS ON SHEET 2/2

	Endat ECN 1113 (V)	Endat EQN 1125 (W)
EX620	310	310
EX630	335	335
EX630	335	335
EX630	360	360

WEIGHT	
Motor w/ without brake w/ with brake	EX620 EX630
10 kg 11 kg	12 N.m 12 N.m
12.5 kg 13.5 kg	8 N.m 8 N.m

BRAKE	
Supply voltage : 24V	±10%
Static torque	

DIMENSIONS				
Feedback option (feedback letter)	Resolver ratio 0.5 (A) encoder (X)	Sensorless (Y)	Low cost encoder (X)	Endat
without brake L (mm)	290	290	290	310
with brake L (mm)	320	320	320	335
without brake L (mm)	320	320	320	335
with brake L (mm)	345	345	345	360

General tolerances: DIN ISO 2768 mK

Scale: 1:2

Format: A3

Sheet : 1/2

344853 C



### 3.3.8. EX820U EX840U EX860U

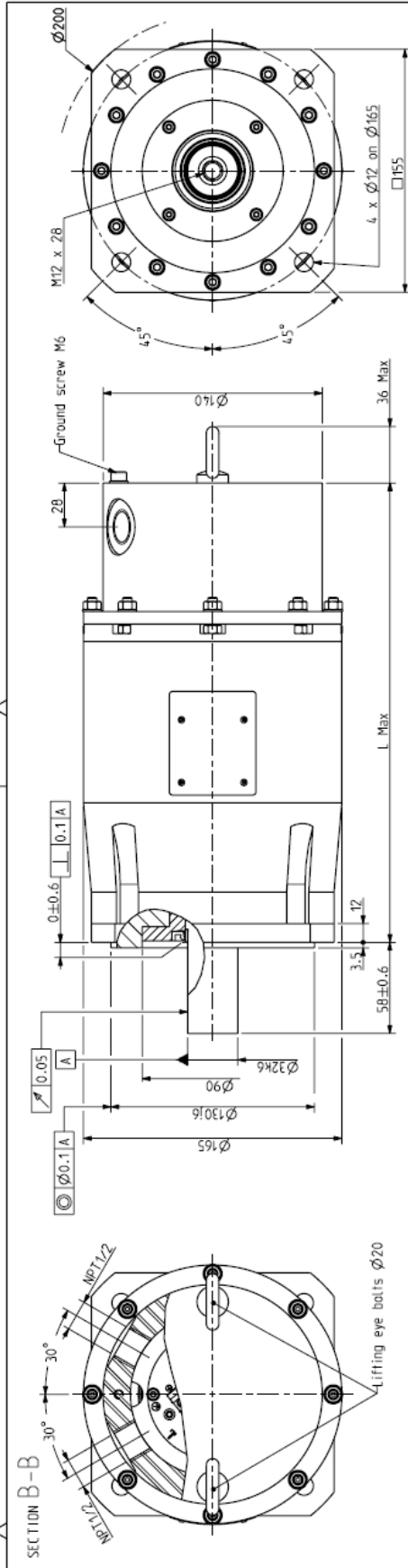

**WITH KEY**

58±0.6

50

4

35.8±0.25

M12 x 28

10

6

**SHAFT END**

M12 x 28

10

6

**WEIGHT**

Motor w/ without brake	w/ ith brake	
EX820	22 kg	25 kg
EX840	28 kg	31 kg
EX860	38 kg	41 kg

**BRAKE**

Supply voltage : 24V    ±10%

Static torque

	EX820	EX840	EX860
20°C	36 N.m	36 N.m	36 N.m
100°C	32 N.m	32 N.m	32 N.m

**UL CERTIFIED**

**E302760**

SAFETY US-CA

Class 1, Division 1, Group C & D  
UL674 : Electric Motors and Generators  
for use in Division 1 Hazardous  
(classified) Locations.

**EX80UR1**

Torque range (depends on length)

Feedback (depends on speed)

Winding (depends on speed)

Brake

IP

0 : IP64  
1 : IP65

Shaft

0 : Plain shaft  
1 : With key

A : Resolver - ratio 0.5  
R : HIPERFACE singleturn SKS36  
S : HIPERFACE multiturn SKM36  
T : HIPERFACE singleturn SRM50  
U : HIPERFACE multiturn SRM50  
V : ENDAT singleturn ECN 1113  
W : ENDAT multiturn EGN 1125  
X : Low cost encoder  
Y : Sensorless

**CONNECTIONS VARIANTS ON SHEET 2/2**

Feedback option (feedback letter)	Resolver ratio 0.5 (A)	Low cost encoder (X)	Sensorless (Y)	Hiperface SKS36 (R)	Hiperface SKM36 (S)	Hiperface SRM50 (T)	Hiperface SRM50 (U)	Endat ECN 1113 (V)	Endat EGN 1125 (W)
EX820	without brake	without brake	295	310	310	330	330	335	335
	with brake	with brake	330	345	345	365	370	370	370
EX840	without brake	without brake	355	370	370	390	395	395	395
	with brake	with brake	390	405	405	425	430	430	430
EX860	without brake	without brake	475	430	430	450	455	455	455
	with brake	with brake	450	465	465	485	490	490	490

**Parker**

8 Avenue du lac, 89249  
21007-010N, cebs-FRANCE  
www.550drives.com

Scale: 2:5

Drawn: 08/09/09

Visa: 00

General tolerances: DIN ISO 2768 mK

Material: A AM 24574 08/07/16 SD

Format: A3

EX800U

OUTLINE DRAWING

344854

Sheet : 1/2

F E S G I

x

This document is the property of PARKEX. Transmission as well as reproduction or copy is not permitted without written authorization.

### 3.4. Motor Mounting

#### 3.4.1. Motor mounting

By flange in any direction

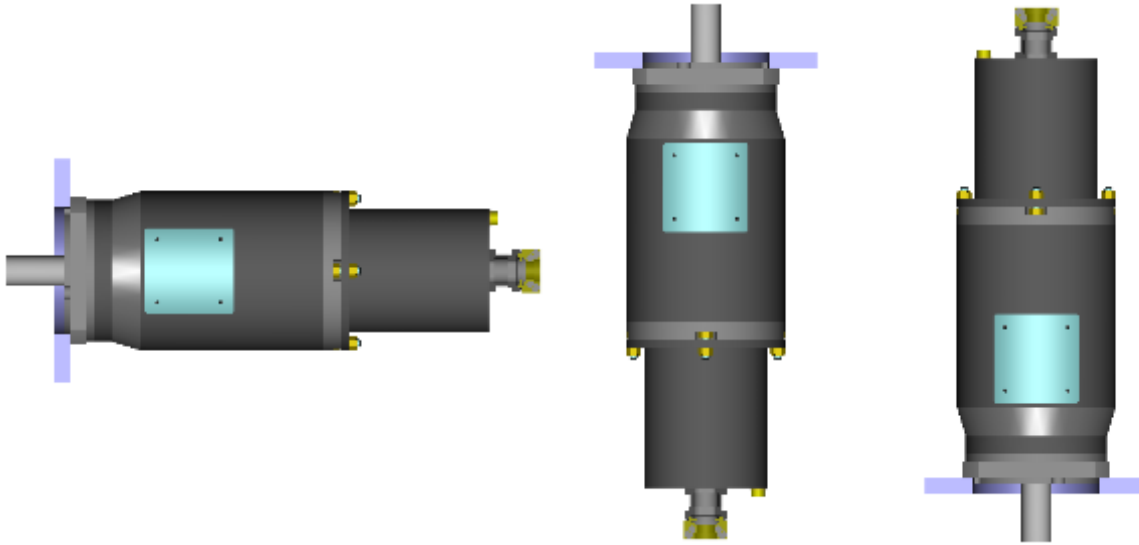

#### 3.4.2. Installation of ATEX machines

Keep in mind that EX motors are equipments with protect mode “db” flameproof enclosure for hazardous area of gas and with protection by enclosure “tb” for hazardous area of dust ignition.



When installing electric system in hazardous locations, carefully observe the corresponding country regulations.

### 3.4.3. Frame recommendation

	<p><u>Warning</u> : The user has the entire responsibility to design and prepare the support, the coupling device, shaft line alignment, and shaft line balancing.</p>
---	--

Foundation must be even, sufficiently rigid and shall be dimensioned in order to avoid vibrations due to resonances.

The servomotors need a rigid support, machined and of good quality.

The maximum flatness of the support has to be lower than 0.05mm.

The motor vibration magnitudes in rms value are in accordance with IEC 60034-14 grade A:

- maximum rms vibration velocity for EX is 1.3mm/s for rigid mounting

	<p><u>Warning</u> : A grade A motor (according to IEC 60034-14) well-balanced, may exhibit large vibrations when installed in-situ arising from various causes, such as unsuitable foundations, reaction of the driven motor, current ripple from the power supply, etc.</p> <p>Vibration may also be caused by driving elements with a natural oscillation frequency very close to the excitation due to the small residual unbalance of the rotating masses of the motor.</p> <p>In such cases, checks should be carried out not only on the machine, but also on each element of the installation. (See ISO 10816-3).</p>
--	--

	<p><u>Warning</u> : A bad setting of the electronic control of the close loop (gain too high, incorrect filtering ...) can occur an instability of the shaft line, vibration or/and breakdown - . Please consult us</p>
---	---

### 3.5. Shaft Loads

#### 3.5.1. Vibration resistance to shaft end

Frequency domain :10 to 55 Hz according to EN 60068 -2-6

Vibration resistance to the shaft end :

- radial 3 g
- axial 1 g

#### 3.5.2. Maximum load acceptable on the shaft



**Warning :**

The values written in the table are given for a load placed on the middle of the shaft like the picture below.

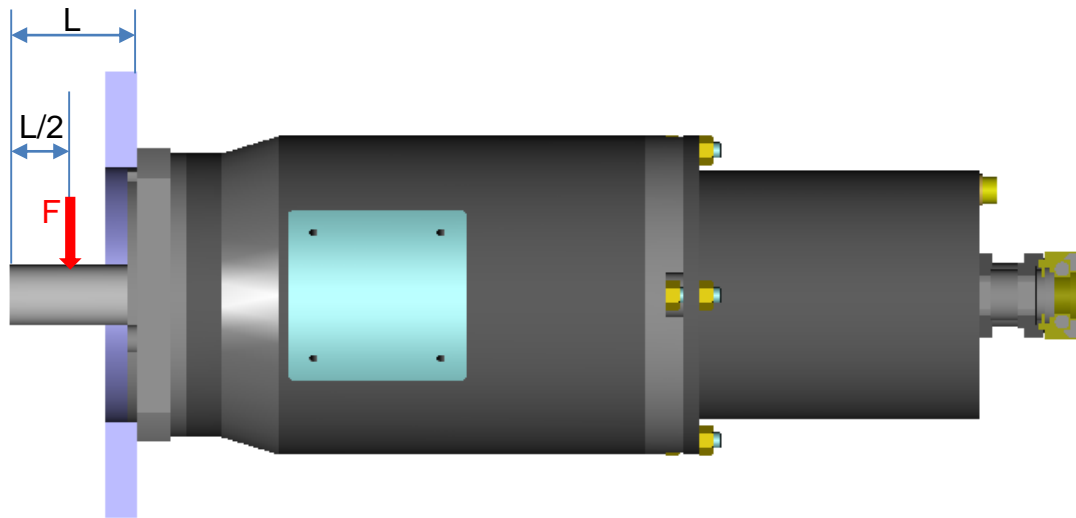

**Warning :**

Due to the small ATEX airgap requirements between the shaft and the front flange, the radial loads on the shaft are lower than standard NX motors.

The ATEX airgap requirements depend on the volume of the motor and can lead to lower radial loads for bigger motors.



**Warning :**

Regarding to these shaft loads, you must'nt use a pulley belt system without a load take-up system.

Type	Maximum shaft load F [N]
EX310	100
EX430	500
EX630	500
EX860	250

### 3.6. Cooling

In compliance with the IEC 60034-1 standards:

The ambient air temperature shall not be less than **-20°C** and more than **40°C**.



It is possible to use the motors in an higher ambient temperature between **40°C** to **60°C** but with an associated derating to the motor performances.



Warning: To reach the motor performances calculated, the motor must be thermally well connected to a aluminium flange with a dimension of 400 mm x 400 mm and with a thickness of 12 mm.



Caution: the ambient air temperature shall not exceed 40°C (respectively 60°C with associated derating) in the vicinity of the motor flange



Warning: A significant part of the heat produced by the motor is evacuated through the flange.

- if the air is not able to circulate freely around the motor,
- if the motor is mounted on a surface that dissipates not well the heating (surface with little dimensions for instance),
- if the motor is thermally isolated,
- if the motor is mounted on a warm surface (mounted on a gearbox for instance),

then the motor has to be used at a torque less than the rated torque.

### 3.7. Thermal Protection

The drive guarantees a 1st level of safety but it is not sufficient. Safety is guaranteed by the independent relay system described in the connection diagram (§4.3.3) which constitutes an independent protection circuit meeting safety classification SIL2 in accordance with the standard IEC 61508.

In the motor, there are two kinds of thermal sensors used for the safety. Both devices are wired in-series with the coil of the drive power contactor.

- Two thermostiches fitted in the servomotor coil mean that the circuit is mechanically opened on a basis at  $125^{\circ}\text{C}\pm 5^{\circ}\text{C}$ . This protection is reversible, after a decreasing of the temperature under the basis, the circuit is mechanically closed.
- A thermofuse fitted with a contact on the servomotor frame means that the circuit is mechanically opened on a permanent basis at  $130^{\circ}\text{C}-5^{\circ}\text{C}$ . In case of an over temperature and thermostiches default, the thermo fuse cuts off permanently the power supply to the contactor coil.

Both thermostiches and thermofuse are wired in-series with the coil of the drive power contactor. If the maximum temperature is reached, the thermostiches are opened and temporarily cut off the power supply to the contactor coil. If the temperature reaches a dangerous level (thermostiches default), the thermofuse melts; permanently cutting off the power supply to the contactor coil.

The drive can be equipped with a Safe Torque Off function in accordance with EN ISO13849-1 : 2006 and EN 61800-5-2:2006 and validated by a notified organization. In this case the safety system can be connected to this function with a validation of a notified organization.

**Caution :** (see diagrams §4.3.3) :

- Make sure the parameters of the contactor and the connecting are strictly followed.
- The motor is out of order if the thermofuse is activated!
- The power contactor KM1 should be replaced in accordance with its operation lifespan and number of manoeuvres. A yearly test, intended to check on the ability of the contactor to detect condition changes, should also be carried out.
- The thermal sensors, due to their thermal inertia, are unable to follow very fast winding temperature variations. They acheive their thermal steady state after a few minutes.



Warning: To protect correctly the motor against very fast overload, please refer to 3.1.6. Peak current limitations

### 3.8. Power Electrical Connections

#### 3.8.1. Inlet cables for ATEX/IECEx version.

The servomotors EX have two cable glands with metric thread :one for the feedback cable and the other for the power. These cable glands are place in axial or radial position on the feedback cover depending the motor option.

The informations of these cable glands are placed in the §4.4.

The cable gland expected for the feedback cable could be replace by an ATEX thread cap in case of a servomotor in sensorless.

It is forbidden to change a cable gland without the Parker agreement.

#### 3.8.2. Wires sizes



In every country, you must respect all the local electrical installation regulations and standards.

Not limiting example in France: NFC 15-100 or IEC 60364 as well in Europe.



Cable selection depends on the cable construction, so refer to the cable technical documentation to choose wire sizes



Some drives have cable limitations or recommendations; please refer to the drive technical documentation for any further information.

#### Cable selection



At standstill, the current must be limited at 80% of the low speed current  $I_0$  and cable has to support peak current for a long period. So, if the motor works at standstill, the current to select wire size is  $\sqrt{2} \times 0.8 I_0 \cong 1,13 \times I_0$ .



For the ATEX installations in ambient temperature of 40°C or 60°C, you have to use special cables C2 type auto-extinguish regarding the standard EN 50265-2-1.

Warning : the cables used in the :

- EX3 can reach a temperature of 80°C,
- EX4 can reach a temperature of 91°C,
- EX6 can reach a temperature of 95°C,
- EX8 can reach a temperature of 95°C

Warning : for a safe use, the EX3 servomotors has to be used with cable which withstand a maximum temperature of 80°C.

Warning : for a safe use, the EX4/EX6/EX8 servomotors has to be used with cable which withstand a maximum temperature of 100°C.



	<p>It is mandatory to connect 2 (green-yellow) ground cables between the motor frame and machine.</p> <ul style="list-style-type: none"> <li>•the first one is connected to ground screw on the PCB inside the motor,</li> <li>•the other one is connected to the external motor housing</li> </ul> <p>The connecting of these two grounding devices is mandatory in order to comply with ATEX standard IEC/EN 60079-0.</p> <p>The ground cable cross-section must be the same as the power cable cross-section</p>
---	---

**3.8.3. Conversion Awg/kcmil/mm<sup>2</sup>:**

Awg	kcmil	mm <sup>2</sup>
	500	253
	400	203
	350	177
	300	152
	250	127
0000 (4/0)	212	107
000 (3/0)	168	85
00 (2/0)	133	67.4
0 (1/0)	106	53.5
1	83.7	42.4
2	66.4	33.6
3	52.6	26.7
4	41.7	21.2
5	33.1	16.8
6	26.3	13.3
7	20.8	10.5
8	16.5	8.37
9	13.1	6.63
10	10.4	5.26
11	8.23	4.17
12	6.53	3.31
14	4.10	2.08
16	2.58	1.31
18	1.62	0.82
20	1.03	0.52
22	0.63	0.32
24	0.39	0.20
26	0.26	0.13

**3.8.4. Motor cable length**

For motors windings which present low inductance values or low resistance values, the own cable inductance, respectively own resistance, in case of large cable length can greatly reduce the maximum speed of the motor. Please contact PARKER for further information.

	<p><u>Caution:</u> It might be necessary to fit a filter at the servo-drive output if the length of the cable exceeds 25 m. Consult us.</p>
	<p>The length of the cable must be of 3 meters min.</p>



### 3.8.5. Mains supply connection diagrams

#### 3.8.5.1. EX310E

Certification :  
INERIS 03ATEX0060X  
INE 15-0060X

**Resolver and CR410 connection**  
Feedback letter : A/E/G

U : Phase U  
V : Phase V  
W : Phase W  
TH- : Thermic protector  
TH+ : Thermic protector  
BR- : Brake- (option)  
BR+ : Brake+ (option)  
S1 : Resolver 1  
S2 : Resolver 2  
S3 : Resolver 3  
S4 : Resolver 4  
R1 : Resolver 5  
R2 : Resolver 6  
B : Shield option (screw M3)

⊕ Ground

SCALE : 3/2

Rotor is rotating in clockwise viewed from shaft end view.

S1 = Cos -	S2 = Sin -	R1 = Excitation +
S3 = Cos +	S4 = Sin +	R2 = Excitation -

**Low cost encoder connection**  
Feedback letter : X

U : Phase U  
V : Phase V  
W : Phase W  
TH- : Thermic protector  
TH+ : Thermic protector  
BR- : Brake- (option)  
BR+ : Brake+ (option)  
1 : A  
2 : A'  
3 : B  
4 : B'  
5 : Z  
6 : Z'  
7 : 0  
8 : Vcc  
B : Shield option (screw M3)

⊕ Ground

SCALE : 3/2

**Sensorless connection**  
Feedback letter : Y

U : Phase U  
V : Phase V  
W : Phase W  
TH- : Thermic protector  
TH+ : Thermic protector  
BR- : Brake- (option)  
BR+ : Brake+ (option)  
B : Shield option (screw M3)

⊕ Ground

SCALE : 3/2

**Hiperface connection**  
Feedback letter : R/S

U : Phase U  
V : Phase V  
W : Phase W  
TH- : Thermic protector  
TH+ : Thermic protector  
BR- : Brake- (option)  
BR+ : Brake+ (option)  
1 : Encoder  
2 : Encoder gnd  
3 : Encoder refSIN  
4 : Encoder refCOS  
5 : Encoder DATA +  
6 : Encoder DATA -  
7 : Encoder +SIN  
8 : Encoder -COS  
B : Shield option (screw M3)

⊕ Ground

SCALE : 3/2

**Encoder SETTINGS**

**Resolver setting**  
Feedback letter : A/E/G  
Motor powered by direct current at the current nominal value (W+ and V-). The shift is 90° electrical.

**Low cost encoder setting**  
Feedback letter : X  
Engine driven clockwise shaft end side. Switching signal V is in phase with FEM UV.

**Encoder SETTINGS**

**Hiperface SKS/SKM setting**  
Feedback letter : R/S  
Motor powered by direct current at the current nominal value (W+ and V-). Value in encoder memory is 205.

**Masse :**

General tolerances  
DIN ISO 2768 mK

Design	11/09/09	00	Visé
C	AM 24/08	22/04/13	SD
B	AM 23/00	27/04/11	YG
A	AM 23/00	10/12/09	SD

D AM 24/578 22/07/16 SD

Etchelle  
3:10

EX300

OUTLINE DRAWING

Sheet : 2/2

Format	F	E	S	G	I
A3		x			

344487

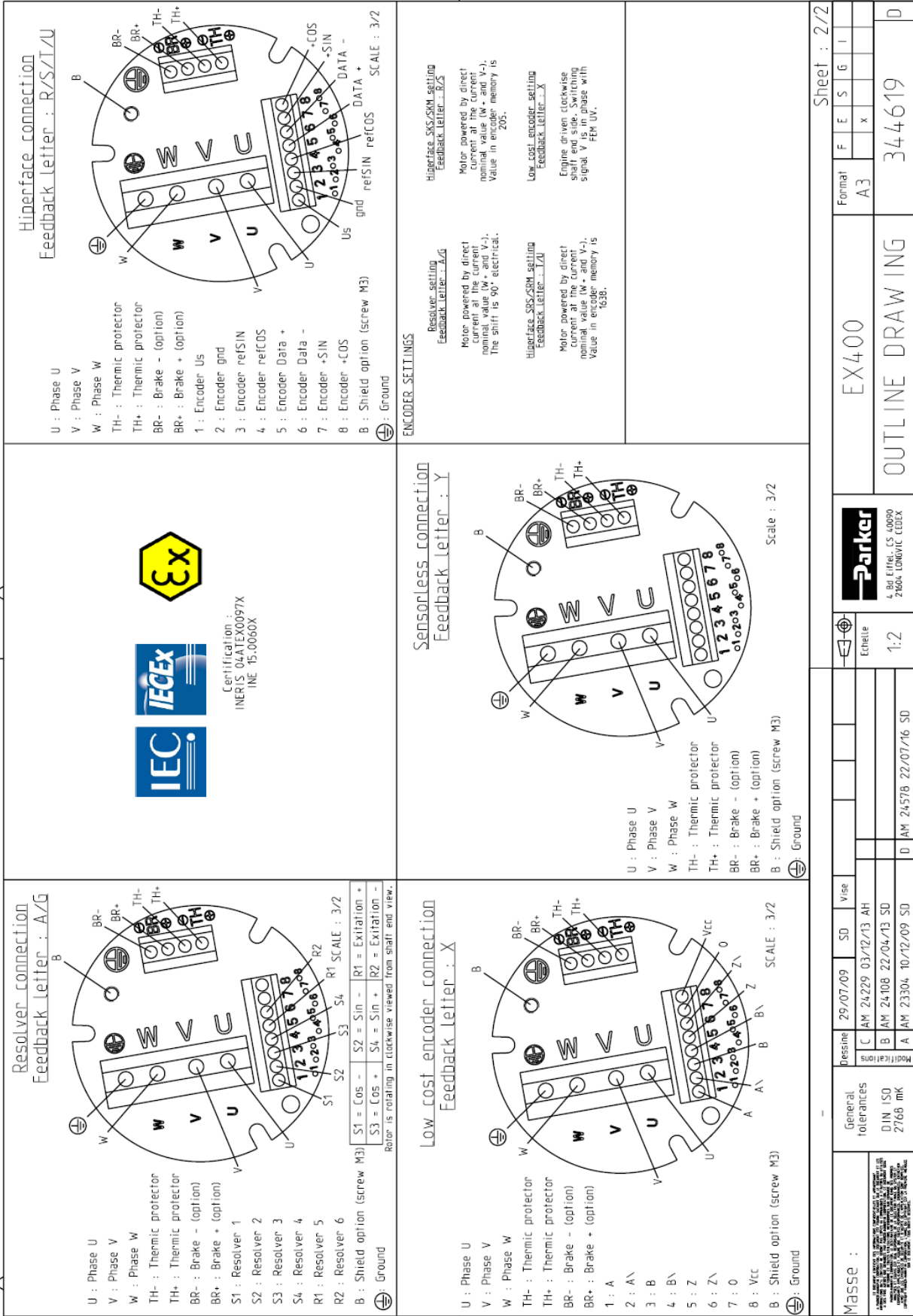

Certification :  
INERIS 04-ATEX0097X  
INE 15-0060X

Masse :		Pressline		29/07/09	SD	Visé
General tolerances		C AM 24229		03/12/13	AH	
DIN ISO 2768 mK		B AM 24108		22/04/13	SD	
		A AM 23304		10/12/09	SD	
Ethelle		D AM 24578		22/07/16	SD	
1:2		D				
OUTLINE DRAWING		344619		D		
EX400		Format A3		Sheet : 2/2		

**Resolver connection**  
Feedback letter : A/Z/G

U : Phase U  
V : Phase V  
W : Phase W  
TH- : Thermic protector  
TH+ : Thermic protector  
BR- : Brake - (option)  
BR+ : Brake + (option)  
S1 : Resolver 1  
S2 : Resolver 2  
S3 : Resolver 3  
S4 : Resolver 4  
R1 : Resolver 5  
R2 : Resolver 6  
B : Shield option (screw M4)

Scale : 2/3

S1 = Cos - S2 = Sin - R1 = Excitation +  
S3 = Cos + S4 = Sin + R2 = Excitation -

Rotor is rotating in clockwise viewed from shaft end view.

**Low cost encoder connection**  
Feedback letter : X

U : Phase U  
V : Phase V  
W : Phase W  
TH- : Thermic protector  
TH+ : Thermic protector  
BR- : Brake - (option)  
BR+ : Brake + (option)  
1 : A  
2 : A'  
3 : B  
4 : B'  
5 : Z  
6 : Z'  
7 : 0  
B : Vcc  
B : Shield option (screw M4)

Scale : 2/3

**HiPerface connection**  
Feedback letter : R/S/T/U

U : Phase U  
V : Phase V  
W : Phase W  
TH- : Thermic protector  
TH+ : Thermic protector  
BR- : Brake - (option)  
BR+ : Brake + (option)  
1 : Encoder Us  
2 : Encoder gnd  
3 : Encoder refSIN  
4 : Encoder refCOS  
5 : Encoder Data +  
6 : Encoder Data -  
7 : Encoder + SIN  
8 : Encoder + COS  
B : Shield option (screw M4)

Scale : 2/3

**Encoder SETTINGS**

Setting	Feedback letter	Description
Resolver setting	A/Z/G	Motor powered by direct current at the correct nominal value (W+ and V-). The shift is 90° electrical.
HiPerface SRS/SRM setting	R/S	Motor powered by direct current at the correct nominal value (W+ and V-). Value in encoder memory is 205.
HiPerface SRS/SRM setting	T/U	Motor powered by direct current at the correct nominal value (W+ and V-). Value in encoder memory is 470.
Endat setting	V/W	Motor powered by direct current at the correct nominal value (W+ and V-). Value in encoder memory is 1638.
Low cost encoder setting	X	Engine driven clockwise shield store. Switching signal V is in phase with PEM UV.

**Endat connection**  
Feedback letter : V/W

U : Phase U  
V : Phase V  
W : Phase W  
TH- : Thermic protector  
TH+ : Thermic protector  
BR- : Brake - (option)  
BR+ : Brake + (option)  
1 : Encoder Up 5V ±5%  
2 : Encoder 0V  
3 : Encoder A +  
4 : Encoder A -  
5 : Encoder B +  
6 : Encoder B -  
7 : Encoder DATA  
8 : Encoder DATA  
9 : Encoder CLOCK  
10 : Encoder CLOCK  
B : Shield option (screw M4)

Scale : 2/3

**Sensorless connection**  
Feedback letter : Y

U : Phase U  
V : Phase V  
W : Phase W  
TH- : Thermic protector  
TH+ : Thermic protector  
BR- : Brake - (option)  
BR+ : Brake + (option)  
B : Shield option (screw M4)

Scale : 2/3

**Resolver connection**  
Feedback letter : A/Z/G

U : Phase U  
V : Phase V  
W : Phase W  
TH- : Thermic protector  
TH+ : Thermic protector  
BR- : Brake - (option)  
BR+ : Brake + (option)  
S1 : Resolver 1  
S2 : Resolver 2  
S3 : Resolver 3  
S4 : Resolver 4  
R1 : Resolver 5  
R2 : Resolver 6  
B : Shield option (screw M4)

Scale : 2/3

S1 = Cos - S2 = Sin - R1 = Excitation +  
S3 = Cos + S4 = Sin + R2 = Excitation -

Rotor is rotating in clockwise viewed from shaft end view.

**Low cost encoder connection**  
Feedback letter : X

U : Phase U  
V : Phase V  
W : Phase W  
TH- : Thermic protector  
TH+ : Thermic protector  
BR- : Brake - (option)  
BR+ : Brake + (option)  
1 : A  
2 : A'  
3 : B  
4 : B'  
5 : Z  
6 : Z'  
7 : 0  
B : Vcc  
B : Shield option (screw M4)

Scale : 2/3

**HiPerface connection**  
Feedback letter : R/S/T/U

U : Phase U  
V : Phase V  
W : Phase W  
TH- : Thermic protector  
TH+ : Thermic protector  
BR- : Brake - (option)  
BR+ : Brake + (option)  
1 : Encoder Us  
2 : Encoder gnd  
3 : Encoder refSIN  
4 : Encoder refCOS  
5 : Encoder Data +  
6 : Encoder Data -  
7 : Encoder + SIN  
8 : Encoder + COS  
B : Shield option (screw M4)

Scale : 2/3

**Resolver setting**  
Feedback letter : A/Z/G

Motor powered by direct current at the correct nominal value (W+ and V-). The shift is 90° electrical.

**HiPerface SRS/SRM setting**  
Feedback letter : R/S

Motor powered by direct current at the correct nominal value (W+ and V-). Value in encoder memory is 205.

**HiPerface SRS/SRM setting**  
Feedback letter : T/U

Motor powered by direct current at the correct nominal value (W+ and V-). Value in encoder memory is 470.

**Endat setting**  
Feedback letter : V/W

Motor powered by direct current at the correct nominal value (W+ and V-). Value in encoder memory is 1638.

**Low cost encoder setting**  
Feedback letter : X

Engine driven clockwise shield store. Switching signal V is in phase with PEM UV.

**General tolerances**

DIN ISO 2768 mK

Pressing: 07/10/09 SD Vise

C AM 24229 03/12/13 AH

B AM 24108 22/04/13 SD

A AM 23304 10/12/09 SD

Sheet : 2/2

Format A3

EX600

OUTLINE DRAWING

344550

D

**Masse :**

4 84 Eiffel-LS 40090  
21664 LOMBVIC CEDEX

**Parker**

Enchele

1:2

### 3.8.5.4. EX820E, EX840E, EX860E

<p style="text-align: center;"><b>Resolver connection</b> Feedback letter : A</p> <p>U : Phase U V : Phase V W : Phase W TH+ : Thermic protector TH- : Thermic protector BR+ : Brake- (option) BR- : Brake+ (option) S1 : Resolver 1 S2 : Resolver 2 S3 : Resolver 3 S4 : Resolver 4 R1 : Resolver 5 R2 : Resolver 6 B : Shield option (screw M4) Ground</p> <p style="text-align: right;">Scale : 2/3</p>	<p style="text-align: center;"><b>Hiperface connection</b> Feedback letter : R/S/T/U</p> <p>U : Phase U V : Phase V W : Phase W TH+ : Thermic protector TH- : Thermic protector BR+ : Brake- (option) BR- : Brake+ (option) 1 : Encoder US 2 : Encoder gnd 3 : Encoder refSIN 4 : Encoder refCOS 5 : Encoder DATA + 6 : Encoder DATA - 7 : Encoder -SIN 8 : Encoder -COS B : Shield option (screw M4) Ground</p> <p style="text-align: right;">Scale : 2/3</p>	<p style="text-align: center;"><b>Endat connection</b> Feedback letter : V/W</p> <p>U : Phase U V : Phase V W : Phase W TH+ : Thermic protector TH- : Thermic protector BR+ : Brake- (option) BR- : Brake+ (option) 1 : Encoder up 5V ±5% 2 : Encoder OV 3 : Encoder A+ 4 : Encoder A- 5 : Encoder B+ 6 : Encoder B- 7 : Encoder Data 8 : Encoder Data\  9 : Encoder Clock 10 : Encoder Clock\  B : Shield option (screw M4) Ground</p> <p style="text-align: right;">Scale : 2/3</p>
<p style="text-align: center;"><b>Low cost encoder connection</b> Feedback letter : X</p> <p>U : Phase U V : Phase V W : Phase W TH+ : Thermic protector TH- : Thermic protector BR+ : Brake- (option) BR- : Brake+ (option) 1 : A 2 : A\  3 : B 4 : B\  5 : Z 6 : Z\  7 : 0 8 : Vcc B : Shield option (screw M4) Ground</p> <p style="text-align: right;">Scale : 2/3</p>	<p style="text-align: center;"><b>Sensorless connection</b> Feedback letter : Y</p> <p>U : Phase U V : Phase V W : Phase W TH+ : Thermic protector TH- : Thermic protector BR+ : Brake- (option) BR- : Brake+ (option) B : Shield option (screw M4) Ground</p> <p style="text-align: right;">Scale : 2/3</p>	<p style="text-align: center;"><b>ENCODER SETTINGS</b></p> <p><b>Resolver setting</b> Feedback letter : A</p> <p>Motor powered by direct current at the current nominal value (W+ and V-). The shift is 90° electrical.</p> <p><b>Hiperface SKS/SKM setting</b> Feedback letter : R/S</p> <p>Motor powered by direct current at the current nominal value (W+ and V-). Value in encoder memory is 205.</p> <p><b>Hiperface SBS/SBM setting</b> Feedback letter : T/U</p> <p>Motor powered by direct current at the current nominal value (W+ and V-). Value in encoder memory is 1638.</p> <p><b>Endat setting</b> Feedback letter : V/W</p> <p>Motor powered by direct current at the current nominal value (W+ and V-). Value in encoder memory is 410.</p> <p><b>Low cost encoder setting</b> Feedback letter : X</p> <p>Engine driven clockwise shaft end side. Switching signal V is in phase with FEM UV.</p> <p style="text-align: center;">           Certification : INERIS 05ATEX0061X       </p>
<p style="text-align: center;">This document is the property of Parker. Any reproduction or copy is not permitted without written authorization.</p>		
<p>General tolerances DIN ISO 2768 mK</p>	<p>Drawn 14/09/09 B AM 24/08 22/04/13 SD A JMY23304 - 10/12/09 SD</p>	<p>Drawn 22/06/10 SD</p>
<p>Scale 2.5</p>		
<p>Format A3</p>		
<p>EX800</p>		
<p>OUTLINE DRAWING</p>		
<p>344664</p>		
<p>Sheet : 2/2</p>		

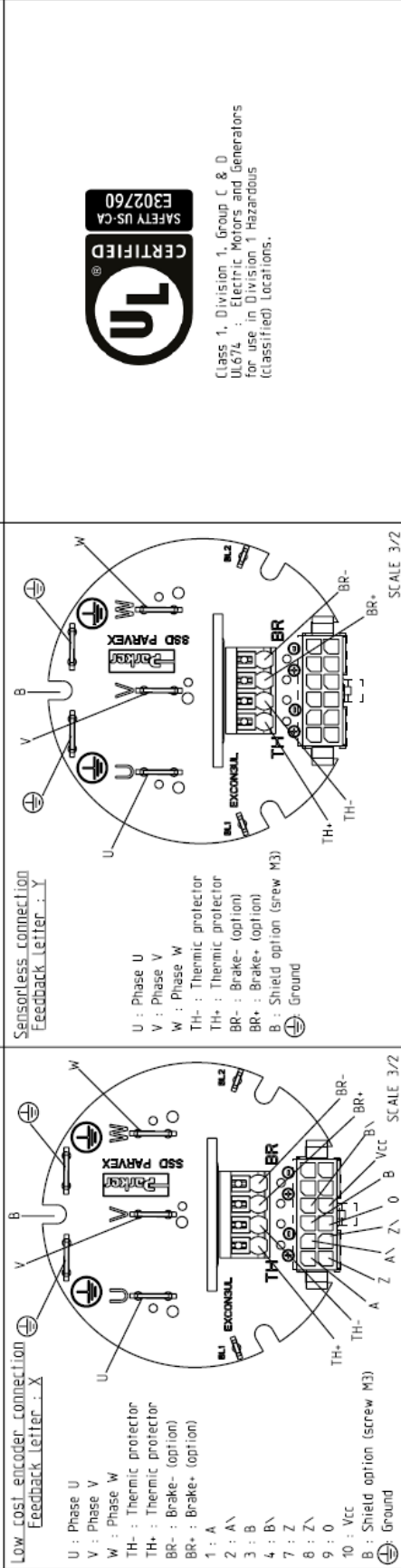
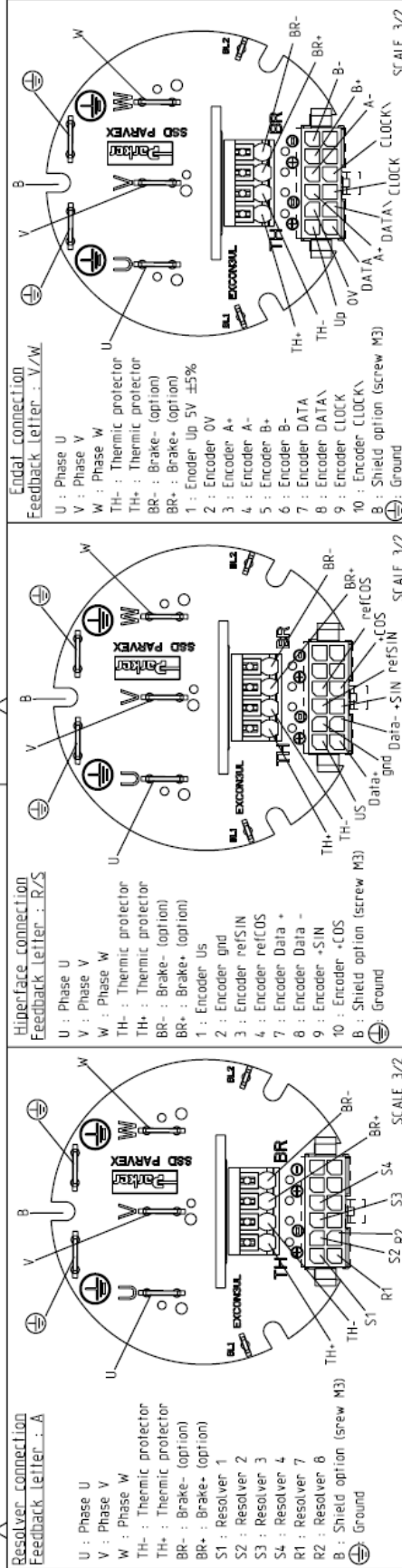

Class 1, Division 1, Group C & D  
UL674 : Electric Motors and Generators  
for use in Division 1 Hazardous  
(classified) locations.

ENCODER SETTINGS

**Resolver setting**  
Feedback letter : A  
Motor powered by direct current at the current nominal value (W+ and V-). The shift is 90° electrical

**Hiperface SKS/SKM setting**  
Feedback letter : R/S  
Motor powered by direct current at the current nominal value (W+ and V-). Value in encoder memory is 205

**Endat setting**  
Feedback letter : V/W  
Motor powered by direct current at the current nominal value (W+ and V-). Value in encoder memory is 410.

**Low cost encoder setting**  
Feedback letter : X  
Engine driven clockwise shaft end side. Switching signal V is in phase with FEM UV.

Drawn	07/09/09	00	Visa						
General tolerances									
DIN ISO 2768 mk									
Modifications									
B AM 24574 06/07/16 SD									
A AM23321 -- 18/07/10 00									
Scale	4:5								
Format	A3								
Sheet : 2/2	F	E	S	G	I				
OUTLINE DRAWING	EX300U				344939				B

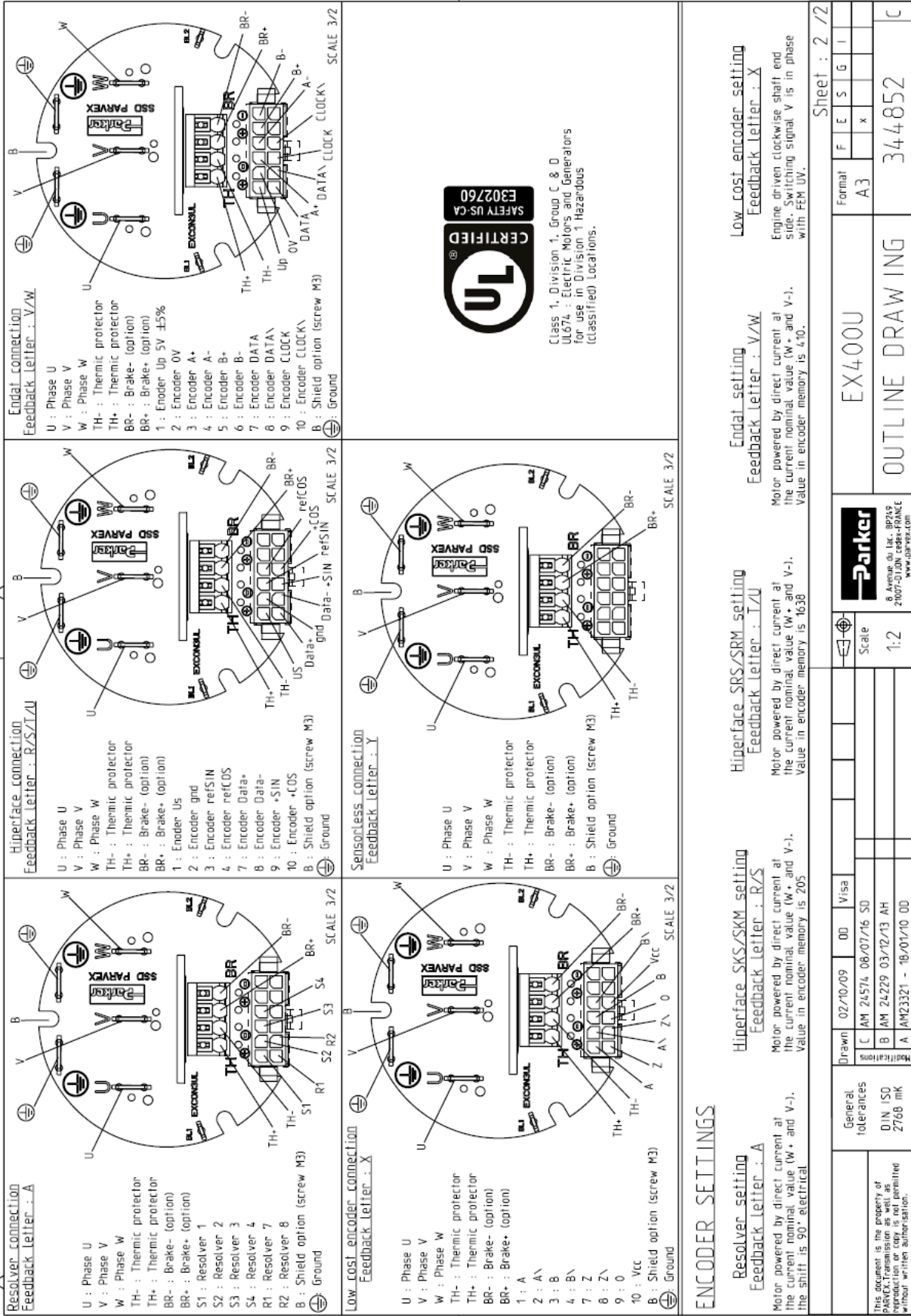

Class 1, Division 1, Group C & D  
UL674 - Electric Motors and Generators  
for use in Division 1 Hazardous  
(classified) Locations.

ENCODER SETTINGS

Resolver setting Feedback Letter : A	Hiperface SKS/SKM setting Feedback Letter : R/S	Hiperface SRS/SRM setting Feedback Letter : T/U	Low Cost Encoder setting Feedback Letter : X
Motor powered by direct current at the current nominal value (W+ and V-). The shift is 90° electrical.	Motor powered by direct current at the current nominal value (W+ and V-). Value in encoder memory is 205.	Motor powered by direct current at the current nominal value (W+ and V-). Value in encoder memory is 1638.	Engine driven clockwise shaft end side. Switching signal V is in phase with FEM UV.
General tolerances DIN ISO 2768 mK	Drawn C AM 24574 08/07/16 SD B AM 24229 03/12/13 AH A AM23321 - 18/01/10 DD	Scale 1:2	Format A3
This document is the property of PARKER. Transmission as well as reproduction or copy is not permitted without written authorization.			Sheet : 2 / 2
OUTLINE DRAWING			344852

### 3.8.5.7. EX620U, EX630U

<p><b>Resolver connection</b> Feedback Letter : A</p> <p>U : Phase U V : Phase V W : Phase W TH+ : Thermic protector TH- : Thermic protector BR+ : Brake- (option) BR- : Brake+ (option) S1 : Resolver 1 S2 : Resolver 2 S3 : Resolver 3 S4 : Resolver 4 R1 : Resolver 5 R2 : Resolver 6 B : Shield option (screw M4)</p> <p style="text-align: right;">SCALE 2/3</p>	<p><b>Hiperface connection</b> Feedback Letter : R/S/T/U</p> <p>U : Phase U V : Phase V W : Phase W TH+ : Thermic protector TH- : Thermic protector BR+ : Brake- (option) BR- : Brake+ (option) 1 : Encoder Us 2 : Encoder gnd 3 : Encoder reLSIN 4 : Encoder reCOS 5 : Encoder Data + 6 : Encoder Data - 7 : Encoder +SIN 8 : Encoder +COS B : Shield option (screw M4)</p> <p style="text-align: right;">SCALE 2/3</p>	<p><b>Endat connection</b> Feedback Letter : V/W</p> <p>U : Phase U V : Phase V W : Phase W TH+ : Thermic protector TH- : Thermic protector BR+ : Brake- (option) BR- : Brake+ (option) 1 : Encoder Up 5V ±5% 2 : Encoder OV 3 : Encoder A+ 4 : Encoder A- 5 : Encoder B+ 6 : Encoder B- 7 : Encoder Data 8 : Encoder Data\N 9 : Encoder Clock 10 : Encoder Clock\N B : Shield option (screw M4)</p> <p style="text-align: right;">SCALE 2/3</p>
<p>Class 1, Division 1, Group C &amp; D UL674 : Electric Motors and Generators for use in Division 1 Hazardous (classified) Locations.</p>		
<p><b>Low cost encoder connection</b> Feedback letter : X</p> <p>U : Phase U V : Phase V W : Phase W TH+ : Thermic protector TH- : Thermic protector BR+ : Brake- (option) BR- : Brake+ (option) 1 : A 2 : A' 3 : B 4 : B' 5 : Z 6 : Z' 7 : 0 8 : Vcc B : Shield option (screw M4)</p> <p style="text-align: right;">SCALE 2/3</p>	<p><b>Sensorless connection</b> Feedback letter : Y</p> <p>U : Phase U V : Phase V W : Phase W TH+ : Thermic protector TH- : Thermic protector BR+ : Brake- (option) BR- : Brake+ (option) B : Shield option (screw M4)</p> <p style="text-align: right;">SCALE 2/3</p>	<p><b>Low cost encoder setting</b> Feedback Letter : X</p> <p><b>Endat setting</b> Feedback Letter : V/W</p> <p><b>Hyperface SRS/SRM setting</b> Feedback Letter : T/U</p> <p>Motor powered by direct current at the current nominal value (W+ and V-). Value in encoder memory is 1638</p>
<p><b>ENCODER SETTINGS</b></p> <p><b>Resolver setting</b> Feedback Letter : A</p> <p>Motor powered by direct current at the current nominal value (W+ and V-). the Shift is 90° electrical</p> <p><b>Hyperface SKS/SKM setting</b> Feedback Letter : R/S</p> <p>Motor powered by direct current at the current nominal value (W+ and V-). Value in encoder memory is 205</p> <p><b>Hyperface SRS/SRM setting</b> Feedback Letter : T/U</p> <p>Motor powered by direct current at the current nominal value (W+ and V-). Value in encoder memory is 1638</p>		
<p>Sheet : 2/2</p>		
<p>EX600U</p>		
<p>OUTLINE DRAWING</p>		
<p>344853</p>		
<p>C</p>		
<p>Format A3</p>		
<p>Scale 1:2</p>		
<p>General tolerances DIN ISO 2768 mK</p>		
<p>This document is the property of PARKER. Transmission as well as reproduction or copy is not permitted without written authorisation.</p>		
<p>Drawn 08/09/09 C AM 24574 08/07/16 SD B AM 24229 29/04/15 AH A AM 24338 26/09/14 AH</p>		

### 3.8.5.8. EX820U, EX840U, EX860U

<p><b>Resolver connection</b> Feedback letter : A</p> <p>U : Phase U V : Phase V W : Phase W TH+ : Thermic protector TH- : Thermic protector BR+ : Brake- (option) BR- : Brake+ (option) S1 : Resolver 1 S2 : Resolver 2 S3 : Resolver 3 S4 : Resolver 4 R1 : Resolver 5 R2 : Resolver 6 B : Shield option (screw M4) ⊕ : Ground</p> <p style="text-align: right;">SCALE 2/3</p>	<p><b>Hiperface connection</b> Feedback letter : R/S/T/U</p> <p>U : Phase U V : Phase V W : Phase W TH+ : Thermic protector TH- : Thermic protector BR+ : Brake- (option) BR- : Brake+ (option) 1 : Encoder Us 2 : Encoder gnd 3 : Encoder refSIN 4 : Encoder refCOS 5 : Encoder Data + 6 : Encoder Data - 7 : Encoder +SIN 8 : Encoder -COS B : Shield option (screw M4) ⊕ : Ground</p> <p style="text-align: right;">SCALE 2/3</p>	<p><b>Endat connection</b> Feedback letter : V/W</p> <p>U : Phase U V : Phase V W : Phase W TH+ : Thermic protector TH- : Thermic protector BR+ : Brake- (option) BR- : Brake+ (option) 1 : Encoder Up 5V 45% 2 : Encoder OV 3 : Encoder A+ 4 : Encoder A- 5 : Encoder B+ 6 : Encoder B- 7 : Encoder Data 8 : Encoder Data 9 : Encoder Clock 10 : Encoder Clock B : Shield option (screw M4) ⊕ : Ground</p> <p style="text-align: right;">SCALE 2/3</p>
<p>Class 1, Division 1, Group C &amp; D UL674 : Electric Motors and Generators for use in Division 1 Hazardous (classified) locations.</p>		
<p><b>Low cost encoder connection</b> Feedback letter : X</p> <p>U : Phase U V : Phase V W : Phase W TH+ : Thermic protector TH- : Thermic protector BR+ : Brake- (option) BR- : Brake+ (option) 9 : U 10 : U 11 : V 12 : V 13 : W 14 : W B : Shield option (screw M4) ⊕ : Ground</p> <p style="text-align: right;">SCALE 2/3</p>	<p><b>Sensorless connection</b> Feedback letter : Y</p> <p>U : Phase U V : Phase V W : Phase W TH+ : Thermic protector TH- : Thermic protector BR+ : Brake- (option) BR- : Brake+ (option) B : Shield option (screw M4) ⊕ : Ground</p> <p style="text-align: right;">SCALE 2/3</p>	<p><b>Encoder Settings</b></p> <p><b>Resolver setting</b> Feedback letter : A Motor powered by direct current at the current nominal value (W+ and V-). The shift is 90° electrical.</p> <p><b>Hiperface SKS/SKM setting</b> Feedback letter : R/S Motor powered by direct current at the current nominal value (W+ and V-). Value in encoder memory is 205.</p> <p><b>Hiperface SRS/SRM setting</b> Feedback letter : T/U Motor powered by direct current at the current nominal value (W+ and V-). Value in encoder memory is 1638.</p> <p><b>Endat setting</b> Feedback letter : V/W Motor powered by direct current at the current nominal value (W+ and V-). Value in encoder memory is 410.</p> <p><b>Low cost encoder setting</b> Feedback letter : X Engine driven clockwise shaft end side. Switching signal V is in phase with FEM UV.</p>
<p>Sheet : 2/2</p>		
<p>Format F L S G I A3 x x</p>		
<p>EX800U</p>		
<p>OUTLINE DRAWING</p>		
<p>344854</p>		
<p>A</p>		
<p>Scale 1/5</p>		
<p>Drawn 08/09/09 OD Vise</p>		
<p>Modifications A JAN 24/574 08/07/16 SD</p>		
<p>General tolerances DIN ISO 2768 mK</p>		
<p>This document is the property of PARKEX-Transmission as well as reproduction or copy is not permitted without written authorisation.</p>		



### 3.8.6. ATEX/IECEx motor connection

#### 3.8.6.1. Connection of the power and the feedback cables with terminals

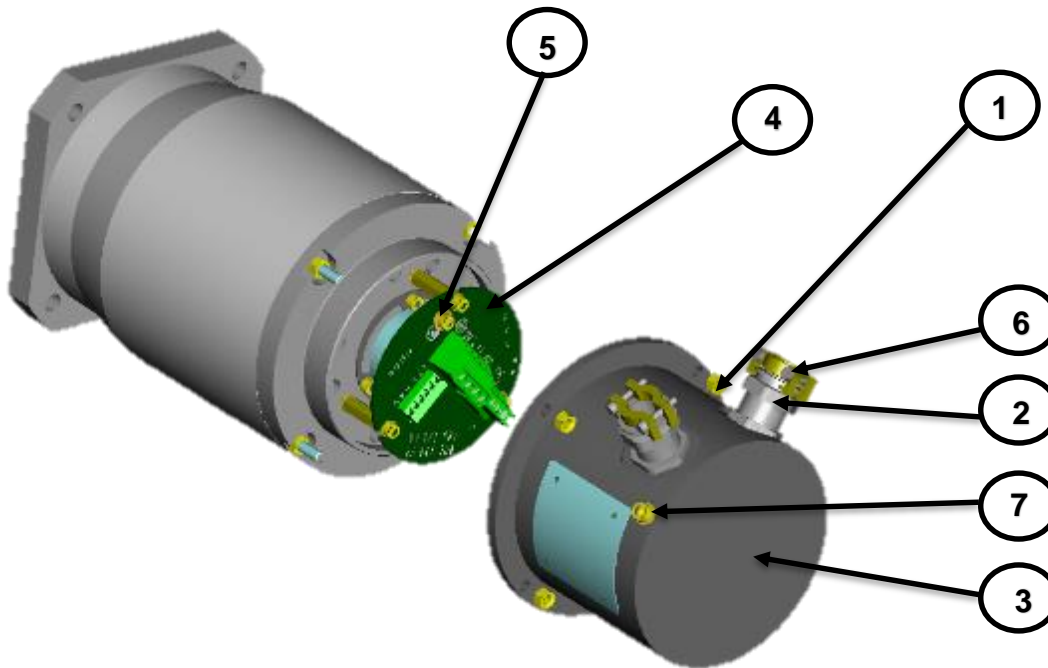

#### **Step 1 – Remove the rear cover :**

1. Unscrew the 4 nuts Ref 1.
2. Unscrew the cable gland caps Ref 2.
3. Remove the cover Ref 3.

#### **Step 2 – Connection of the feedback cable :**

1. Insert the cable in the cable gland Ref 2.
2. Strip the wires on 3 mm.
3. Put the wires in the terminals on the PCB Ref 4 and tighten each screws at the torque value of 0,6 N.m.
4. Make the shielding connection with the connection of the terminal on the screw Ref 5 at the torque value of :

Motor size	Torque (N.m)
EX3-EX4 M3 screw	1,7
EX6-EX8 M4 screw	2,5

5. If the shielding connection is not necessary, cut the wire short the cable.

### **Step 3 – Connection of the power cable :**

1. Insert the cable in the cable gland Ref 2.
2. Strip the wires on 3 mm.
3. Put the wires U, V, W, Ground, TH+ and TH- and also BR+ and BR- in a case of a motor with a brake in the terminal of the PCB Ref 4 and tighten each screws at the torque value of 0,6N.m.
4. Make the shielding connection with the connection of the terminal on the screw Ref 5 at the torque value of :

Motor size	Torque (N.m)
EX3-EX4 M3 screw	1,7
EX6-EX8 M4 screw	2,5

5. If the shielding connection is not necessary, cut the wire short the cable.

### **Step 4 – Fitting of the rear cover :**

1. Slowly take up any slack in the cables and close the cover Ref 3.
2. Tighten the cable gland caps Ref 2 at the torque value of :

Cable gland size	Torque (N.m)
M16	12,5
M20	20

3. Tighten the screws of the connection modules Ref 6 at the torque value of 0,5 N.m.
4. Place the rear cover Ref 3 and take care to don't hurt the toric seal placed on the rear flange.
5. Tighten the 4 nuts Ref 1 at the torque value of :

Motor size	Torque (N.m)
EX3-EX4-EX6 M5 nuts	5,6
EX8 M6 nuts	8,5

6. Connect the outside ground with the screw Ref 7 and tighten it at the torque value of :

Motor size	Torque (N.m)
EX3 M4 screw	2,5
EX4-EX6 M5 screw	5,6
EX8 M6 screw	8,5

### 3.8.6.2. Connection of the feedback and power cable with connector on EX3 :

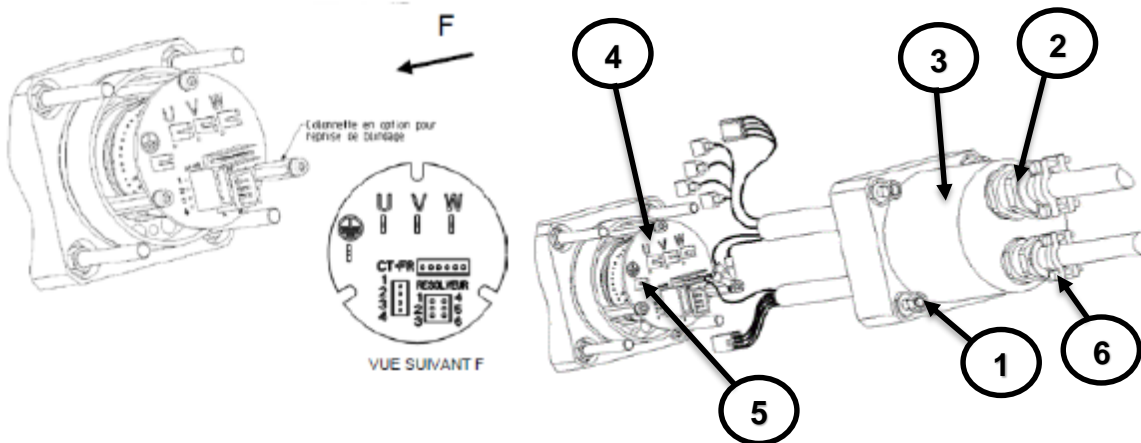

#### **Step 1 – Remove the rear cover :**

1. Unscrew the 4 nuts Ref 1.
2. Unscrew the cable gland caps Ref 2.
3. Remove the cover Ref 3.

#### **Step 2 – Connection of the feedback cable :**

1. Insert the cable in the cable gland Ref 2.
2. Strip the wires on 3 mm and crimp them in the connector.
3. Plug the connector in the terminal of the PCB Ref 4 .
4. Crimp the shielding wire in the connector and plug the connector in the terminal Ref 5.
5. If the shielding connection is not necessary, cut the wire short the cable.

#### **Step 3 – Connection of the power cable :**

1. Insert the cable in the cable gland Ref 2.
2. Strip the wires on 3 mm and crimp them in the connector.
3. Put the wires U, V, W, Ground, TH+ and TH- and also BR+ and BR- in a case of a motor with a brake equipped with their connectors on the terminal of the PCB Ref 4.
4. Crimp the shielding wire in the connector and place the connector in the terminal Ref 5.
5. If the shielding connection is not necessary, cut the wire short the cable.

**Step 4 – Fitting of the rear cover :**

1. Slowly take up any slack in the cables and close the cover Ref 3.
2. Tighten the cable gland caps Ref 2 at the torque value of :

Cable gland size	Torque (N.m)
M16	12,5
M20	20

3. Tighten the screws of the connection modules Ref 6 at the torque value of 0,5 N.m.
4. Place the rear cover Ref 3 and take care to don't cut the toric seal placed on the rear flange.
5. Tighten the 4 nuts Ref 1 at the torque value of 5,6 N.m.
6. Connect the outside ground with the screw Ref 7 and tighten it at the torque value of 2,5 N.m.

### 3.8.7. EX3-EX4 UL connection

#### 3.8.7.1. Connection of the feedback and power cable with connector:

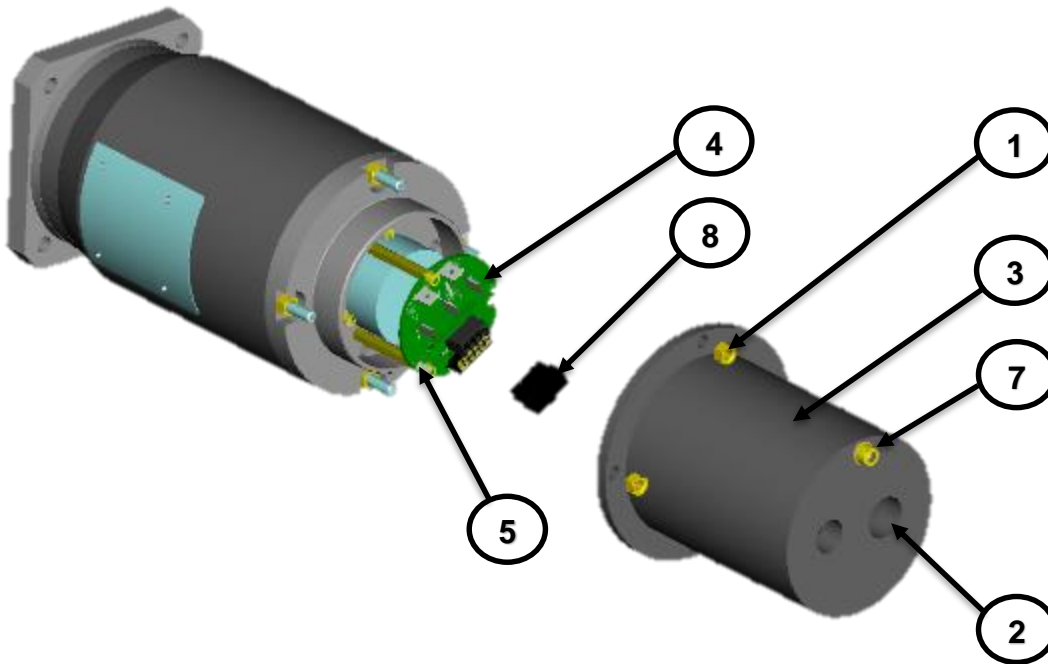

#### Step 1 – Remove the rear cover:

1. Unscrew the 4 nuts Ref 1.
2. Unscrew the cable gland caps Ref 2.
3. Remove the cover Ref 3.

#### Step 2 – Connection of the feedback cable :

1. Insert the cable in the cable gland or conduit stop Ref 2.
2. Strip the wires on 3 mm and crimp them on the contacts supplied in the terminal part kit with the manual crimp tooling Molex N°0638190000 for wire diameter AWG 20-24.
3. Place the contacts in the connector Ref 8.
4. Place the connector inside the PCB connector Ref 4.
5. Crimp the shielding wire in the connector and plug the connector in the terminal Ref 5.
6. If the shielding connection is not necessary, cut the wire short the cable.

### **Step 3 – Connection of the power cable :**

1. Insert the cable in the cable gland or conduit stop Ref 2.
2. Strip the wires on 5mm and crimp the wires U, V, W and Ground in the faston terminals 6,8x0,8.
3. Place the wire U, V, W and Ground on the terminals and plug the wires TH+ and TH- and also BR+ and BR- in a case of a motor with a brake equipped in the terminal of the PCB Ref 4 .
4. Crimp the shielding wire in the faston terminal 2,8x0,8 and plug it on the terminal Ref 5.
5. If the shielding connection is not necessary, cut the wire short the cable.

### **Step 4 – Fitting of the rear cover :**

1. Slowly take up any slack in the cables and close the cover Ref 3.
2. Tighten the cable gland caps or conduits stop Ref 2.
3. Tighten the screws of the connection modules Ref 6 at the torque value of 0,5 N.m.
7. Place the rear cover Ref 3 and take care to don't hurt the toric seal placed on the rear flange.
4. Tighten the 4 nuts Ref 1 at the torque value of 5,6 N.m.
5. Connect the outside ground with the screw Ref 7 and tighten it at the torque value of:

Motor size	Torque value (N.m)
EX3 M4 screw	2,5
EX4 M5 screw	5,6

### 3.8.8. EX6-EX8 UL connection

#### 3.8.8.1. Connection of the feedback and power cable with terminal:

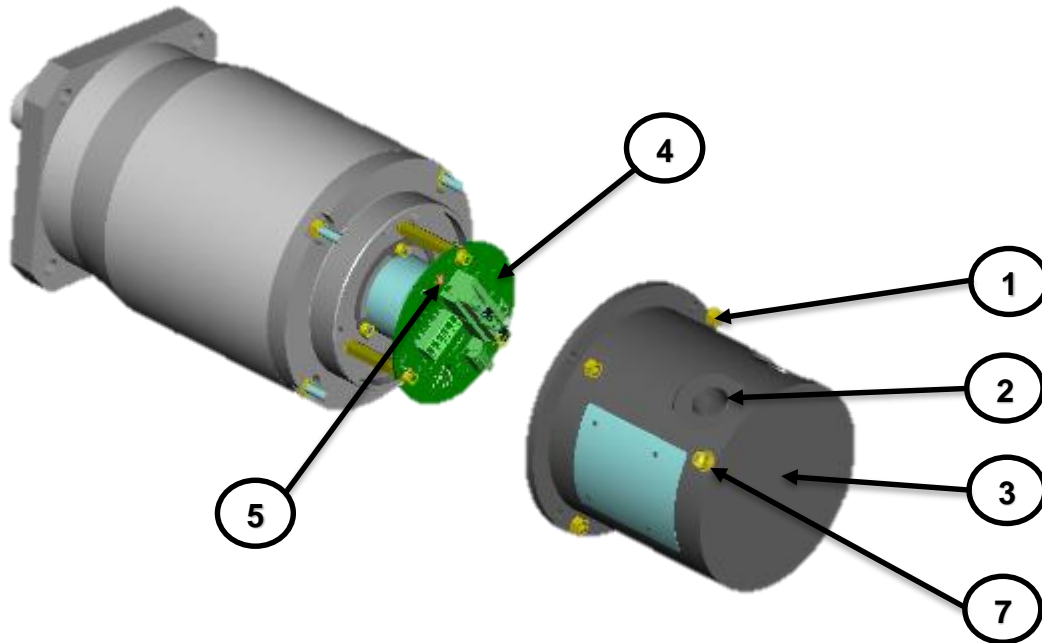

#### Step 1 – Remove the rear cover :

1. Unscrew the 4 nuts Ref 1.
2. Unscrew the cable gland caps Ref 2.
3. Remove the cover Ref 3.

#### Step 2 – Connection of the feedback cable :

1. Insert the cable in the cable gland Ref 2.
2. Strip the wires on 3 mm.
3. Put the wires in the terminals on the PCB Ref 4 and tighten each screws at the torque value of 0,6 N.m.
4. Make the shielding connection with the connection of the terminal on the screw M4 Ref 5 at the torque value of 2,5 N.m.
5. If the shielding connection is not necessary, cut the wire short the cable.

**Step 3 – Connection of the power cable :**

1. Insert the cable in the cable gland Ref 2.
2. Strip the wires on 3 mm.
3. Put the wires U, V, W, Ground, TH+ and TH- and also BR+ and BR- in a case of a motor with a brake in the terminal of the PCB Ref 4 and tighten each screws at the torque value of 0,6N.m.
4. Make the shielding connection with the connection of the terminal on the screw ref 5 at the torque value of 2,5 N.m.
5. If the shielding connection is not necessary, cut the wire short the cable.

**Step 4 – Fitting of the rear cover :**

7. Slowly take up any slack in the cables and close the cover Ref 3.
8. Tighten the cable gland caps or conduits stop Ref 2.
9. Place the rear cover Ref 3 and take care to don't hurt the toric seal placed on the rear flange.
10. Tighten the 4 nuts Ref 1 at the torque value of :

Motor size	Torque (N.m)
EX6 M5 nuts	5,6
EX8 M6 nuts	8,5

11. Connect the outside ground with the screw Ref 7 and tightent it at the torque value of :

Motor size	Torque (N.m)
EX6 M5 screw	5,6
EX8 M6 screw	8,5



### 3.9. Feedback system

#### 3.9.1. Shaft rotation regarding the connection.

With the connection explained in the documentation and with a positive speed request on the drive, the shaft will turn in clockwise direction (see customer shaft end).

#### 3.9.2. Resolver 2 poles transformation ratio = 0.5 – code A

	EX3	EX4, EX6 & EX8
Parker part number	220005P1001	220005P1002
Electrical specification	Values @ 8 kHz	
Polarity	2 poles	
Input voltage	7 Vrms	
Input current	86mA maximum	
Zero voltage	20mV maximum	
Encoder accuracy	± 10' maxi	
Ratio	0,5 ± 5 %	
Output impedance (primary in short circuit whatever the position of the rotor)	Typical 120 + 200j Ω	
Dielectric rigidity (50 – 60 Hz)	500 V – 1 min	
Insulation resistance	≥ 100MΩ	
Rotor inertia	~30 g.cm <sup>2</sup>	
Operating temperature range	-55 to +155 °C	

#### 3.9.3. Sensorless – code K or Y.

The servomotors EX in sensorless version do not have a feedback cable. The connection of the power cable has to be made regarding the connection diagrams in this documentation. In these detailed diagrams §4.3.3, do not take care the connection of the feedback cable and keep the same connections for the other devices.



### **3.9.4. Hiperface encoder singleturn SKS36 (128pulses) – code R**

	<b>EX3, EX4, EX6 &amp; EX8</b>
Model	SKS36 (Sick)
Type	Absolute single turn encoder
Parker part number	220174P0003
Line count	128 sine/cosine periods per revolution
Electrical interface	Hiperface
Position values per revolution	4096
Error limits for the digital absolute value	$\pm 320''$ (via RS485)
Integral non-linearity	$\pm 80''$ (Error limits for evaluating sine/cosine period)
Differential non-linearity	$\pm 40''$ (Non-linearity within a sine/cosine period)
Operating speed	12 000 rpm
Power Supply Current consumption (without load)	7VDC to 12VDC 60mA
Output frequency	0kHz – 65kHz
Operating temperature range	-20°C to +110 °C

### **3.9.5. Hiperface encoder multiturn SKM36 (128pulses) – code S**

	<b>EX3, EX4, EX6 &amp; EX8</b>
Model	SKM36 (Sick)
Type	Absolute multi turn encoder
Parker part number	220174P0004
Line count	128 sine/cosine periods per revolution
Electrical interface	Hiperface
Position values per revolution	4 096
Revolutions	4 096
Error limits for the digital absolute value	$\pm 320''$ (via RS485)
Integral non-linearity	$\pm 80''$ (Error limits for evaluating sine/cosine period)
Differential non-linearity	$\pm 40''$ (Non-linearity within a sine/cosine period)
Operating speed	9000 rpm
Power Supply Current consumption (without load)	7VDC to 12VDC 60mA
Output frequency	0kHz – 65kHz
Operating temperature range	-20°C to +110 °C



**3.9.6. Hiperface encoder singleturn SRS50 (1024pulses) – code T**

	<b>EX4, EX6 &amp; EX8</b>
Model	SRS50 (Sick)
Type	Absolute single turn encoder
Parker part number	220174P0007
Line count	1024 sine/cosine periods per revolution
Electrical interface	Hiperface
Position values per revolution	32 768
Integral non-linearity	$\pm 45''$ ( <i>Error limits for evaluating sine/cosine period</i> )
Differential non-linearity	$\pm 7''$ ( <i>Non-linearity within a sine/cosine period</i> )
Operating speed	6 000 rpm
Power Supply Current consumption (without load)	7VDC to 12VDC 80mA
Output frequency	0kHz – 200kHz
Operating temperature range	-30°C to +115 °C

**3.9.7. Hiperface encoder multiturn SRM50 (1024pulses) – code U**

	<b>EX4</b>	<b>EX6 &amp; EX8</b>
Model	SRM50 (Sick)	
Type	Absolute multi turn encoder	
Parker part number	220174P0009	220174P0005
Line count	1024 sine/cosine periods per revolution	
Electrical interface	Hiperface	
Position values per revolution	32 768	
Revolutions	4 096	
Integral non-linearity	$\pm 45''$ ( <i>Error limits for evaluating sine/cosine period</i> )	
Differential non-linearity	$\pm 7''$ ( <i>Non-linearity within a sine/cosine period</i> )	
Operating speed	6 000 rpm	
Power Supply Current consumption (without load)	7VDC to 12VDC 80mA	
Output frequency	0kHz – 200kHz	
Operating temperature range	-30°C to +115 °C	

**3.9.8. Endat encoder singleturn ECN1113 – code V**

	EX3 & EX4 ATEX	EX3 UL, EX4 UL, EX6 & EX8
Model	N/A	ECN 1113 (Heidenhain)
Type		Absolute single turn encoder
Parker part number		220165P0002
Line count		512 sine/cosine periods per revolution
Electrical interface		Endat2.2
Position values per revolution		8 192 (13 bits)
System accuracy		± 60"
Operating speed		12 000 rpm
Power Supply		3.6VDC to 14VDC 85mA @ 5VDC
Current consumption (without load)		
Cutoff frequency – 3 dB		≥ 190kHz typical
Operating temperature range		-40°C to +115 °C

**3.9.9. Endat encoder multiturn ECN1125 – code W**

	EX3 & EX4 ATEX	EX3 UL, EX4 UL, EX6 & EX8
Model	N/A	ECN 1125 (Heidenhain)
Type		Absolute multi turn encoder
Parker part number		220165P0001
Line count		512 sine/cosine periods per revolution
Electrical interface		Endat2.2
Position values per revolution		8 192 (13 bits)
Revolutions		4 096
System accuracy		± 60"
Operating speed		12 000 rpm
Power Supply		3.6VDC to 14VDC 105mA @ 5VDC
Current consumption (without load)		
Cutoff frequency – 3 dB		≥ 190kHz typical
Operating temperature range		-40°C to +115 °C



With unregulated power supply (AC890 PARKER drive for instance), the max cable length is **65m** with 0.25mm<sup>2</sup> power supply wire due to the voltage drop into the cable itself.

## Maximum Endat cable length

Please refer to the following curve to calculate the max cable length depending on the clock frequency

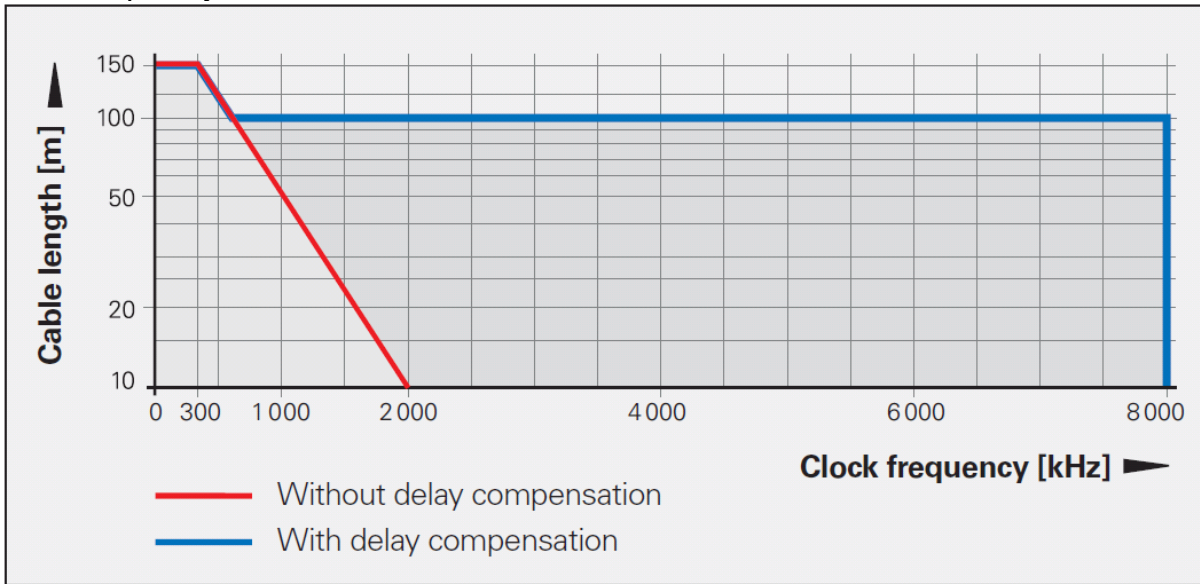

## AC890 PARKER Wiring – EnDat encoder

### From Heidenhain

Data (measured values or parameters) can be transferred bidirectionally between position encoders and subsequent electronics with transceiver components in accordance with RS-485 (differential signals), in synchronism with the clock signal produced by the subsequent electronics.

#### Dimensioning

IC<sub>1</sub> = RS 485 differential line receiver and driver

C<sub>3</sub> = 330 pF

Z<sub>0</sub> = 120 Ω

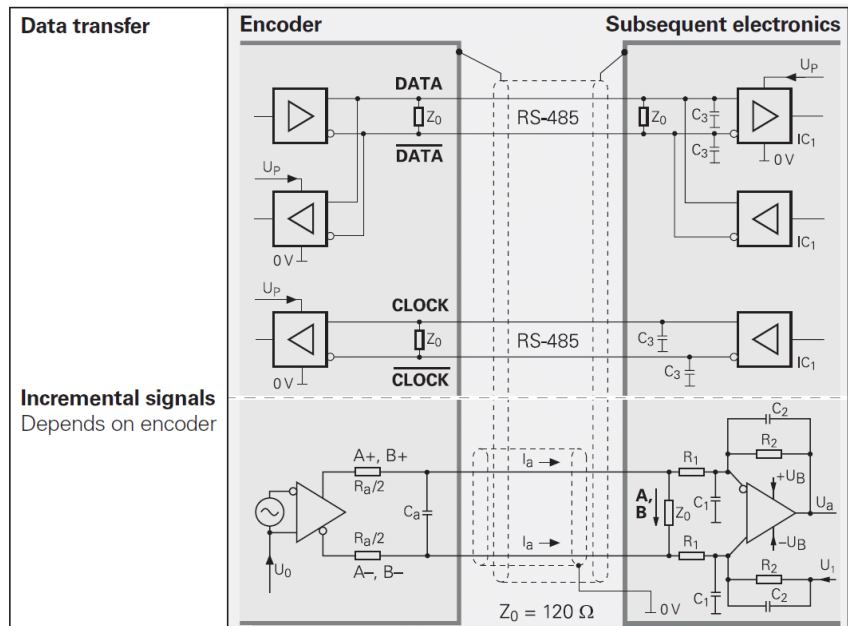



**3.9.10. Incremental encoder - Commuted lines 10 poles – 2048pulses – code X (On request)**

	<b>EX3, EX4, EX6 &amp; EX8</b>
Model	F10 (Hengstler)
Type	Incremental encoder with 10 pole commutation signals
Parker part number	220167P0003
Line count	2048 pulses per revolution
Electrical interface	Line driver 26LS31
System accuracy	Incremental signals $\pm 2.5'$ commutation signals $\pm 6'$
Operating speed	5 000 rpm
Power Supply Current consumption (without load)	5VDC $\pm 10\%$ 100mA
Max pulse frequency	300 kHz
Operating temperature range	0°C to +120 °C

### 3.10. Cables

You can connect EX motors to PARKER servo drives : AC30, AC890, COMPAX3, PSD or SLVD.

You can use complete cable with part number on the tabs below.

The "xxx" in the part number must be replaced by the length in meter with a minimal length of 3m.

Ex : for 20m cable, "xxx" = 020.

#### Special requirements for ATEX servomotors

	<p>For the ATEX installations in ambient temperature of 40°C or 60°C, you have to use special cables C2 type auto-extinguish regarding the standard EN 50265-2-1.</p> <p><u>Warning</u> : the cables used in the :</p> <ul style="list-style-type: none"><li>• EX3 can reach a temperature of 80°C,</li><li>• EX4 can reach a temperature of 91°C,</li><li>• EX6 can reach a temperature of 95°C,</li><li>• EX8 can reach a temperature of 95°C</li></ul> <p><u>Warning</u> : for a safe use, the EX3 servomotors has to be used with cable which withstand a maximum temperature of 80°C.</p> <p><u>Warning</u> : for a safe use, the EX4/EX6/EX8 servomotors has to be used with cable which withstand a maximum temperature of 100°C.</p>
---	--



### **3.10.1. Cable option Max 80°C on the surface ATEX/IECEX**

The servomotors EX are available on demand with cables withstanding a temperature of 80°C on the outside surface.

With this option the EX servomotors must be placed in an area with controlled temperature following the informations written in the tables just below. An over temperature must cut off the power of the motor.

#### **Size EX4 :**

	<b>EX4 certified for an ambient temperature of -20 to +60°C</b>
Ambient temperature for a Parker standard cable using (Max 100°C)	-20 to +60°C
Ambient temperature for an using of cables withstanding a max temperature of 80°C.	-20 to +49°C

#### **Size EX6 :**

	<b>EX6 certified for an ambient temperature of -20 to +40°C</b>	<b>EX6 certified for an ambient temperature of -20 to +60°C</b>
Ambient temperature for Parker standard cable using (Max 100°C)	-20 to +40°C	-20 to +60°C
Ambient temperature for an using of cables withstanding a max temperature of 80°C.	-20 to +37°C	-20 to +45°C

#### **Size EX8 :**

	<b>EX8 certified for an ambient temperature of -20 to +40°C</b>
Ambient temperature for Parker standard cable using (Max 100°C)	-20 to +40°C
Ambient temperature for an using of cables withstanding a max temperature of 80°C.	-20 to +25°C



### 3.10.2. Resolver cable connection for AC890

Cable reference :  
**CS4UA1D1R0xxx**

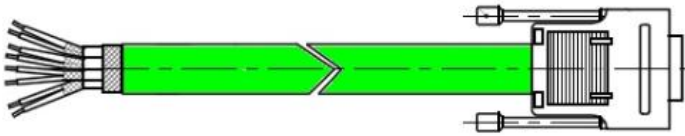

Feedback cable **6537P0059**  
Male 15 pins SUB-D connector reference **AC 80552**  
SUB-D cover reference **220029P0043**  
Pins reference **220029P0021**

**Cable arrangement :**

EX terminals	Identification	Wire colour	SUB-D terminals
1	S1 / Cos -	Black (Black/White pair)	3
2	S2 / Sin -	Black (Black/Blue pair)	1
3	S3 / Cos +	White	11
4	S4 / Sin -	Blue	9
5	R1 / Ref +	Red	8
6	R2 / Ref -	Black (Black/Red pair)	15

### 3.10.3. Endat cable connection for AC890

Cable reference :  
**CS4UV1D1R0xxx**

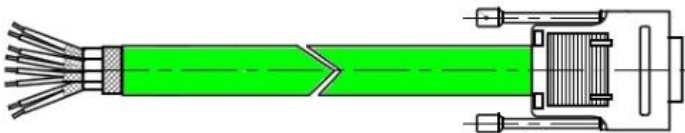

Feedback cable **6537P0059**  
Male 15 pins SUB-D connector reference **AC 80552**  
SUB-D cover reference **220029P0043**  
Pins reference **220029P0021**

**Cable arrangement :**

EX terminals	Identification	Wire colour	SUB-D terminals
1	up	Red	10
2	0V	Black (Black/Red pair)	2
3	A+	Green	3
4	A-	Black (Black/Green pair)	11
5	B+	Blue	1
6	B-	Black (Black/Blue pair)	9
7	Data	White	4
8	Data\	Black (Black/White pair)	12
9	Clock	Yellow	5
10	Clock\	Black (Black/Yellow pair)	13

### 3.10.4. Resolver cable connection for COMPAX3

Cable reference :  
**CC3UA1D1R0xxx**

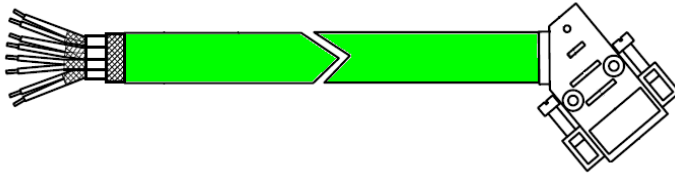

Feedback cable **6537P0059**  
Male 15 pins SUB-D connector reference **220029P0040**  
SUB-D cover reference **220029P0039**

**Cable arrangement :**

EX terminals	Identification	Wire colour	SUB-D terminals
1	S1 / Cos -	Black (Black/White pair)	12
2	S2 / Sin -	Black (Black/Blue pair)	8
3	S3 / Cos +	White	11
4	S4 / Sin -	Blue	7
5	R1 / Ref +	Red	4
6	R2 / Ref -	Black (Black/Red pair)	15

### 3.10.5. Hiperface encoder cable connection for COMPAX3

Cable reference :  
**CC3UR1D1R0xxx**

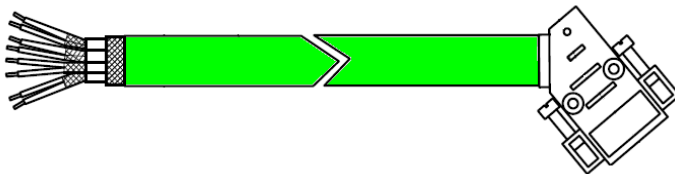

Feedback cable **6537P0059**  
Male 15 pins SUB-D connector reference **220029P0040**  
SUB-D cover reference **220029P0039**

**Cable arrangement :**

EX terminals	Identification	Wire colour	SUB-D terminals
1	Us	Red	4
2	Gnd	Black (Black/Red pair)	15
3	refSin	Black (Black/White pair)	7
4	refCos	Black (Black/Blue pair)	1
5	Data +	Yellow	13
6	Data -	Black (Black/Yellow pair)	14
7	Sin +	White	8
8	Cos +	Blue	12

### 3.10.6. Resolver cable connection for SLVD

Cable reference :  
**CS5UA1D1R0xxx**

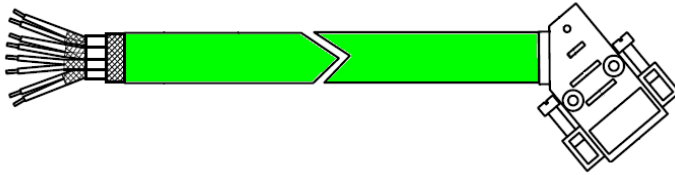

Feedback cable **6537P0059**  
Male 15 pins SUB-D connector reference **220029P0040**  
SUB-D cover reference **220029P0039**

**Cable arrangement :**

EX terminals	Identification	Wire colour	SUB-D terminals
1	S1 / Cos -	White	12
2	S2 / Sin -	Black (Black/Blue pair)	8
3	S3 / Cos +	Black (Black/White pair)	11
4	S4 / Sin -	Blue	7
5	R1 / Ref +	Red	4
6	R2 / Ref -	Black (Black/Red pair)	15

### 3.10.7. Resolver cable connection for 637/638

Cable reference :  
**CS1UA1D1R0xxx**

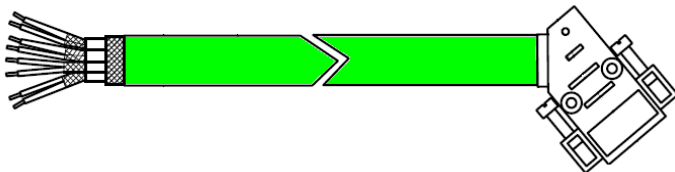

Feedback cable **6537P0059**  
Male 9 pins SUB-D connector reference **220029P0020**  
SUB-D cover reference **220029P0039**  
Pins reference **220029P0021**

**Cable arrangement :**

EX terminals	Identification	Wire colour	SUB-D terminals
1	S1 / Cos -	Black (Black/White pair)	7
2	S2 / Sin -	Black (Black/Blue pair)	4
3	S3 / Cos +	White	3
4	S4 / Sin -	Blue	8
5	R1 / Ref +	Red	5
6	R2 / Ref -	Black (Black/Red pair)	9

### 3.10.8. Hiperface encoder cable connection for 637/638

Cable reference :  
**CS2UR1D1R0xxx**

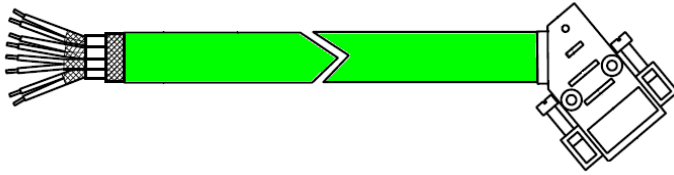

Feedback cable **6537P0059**  
Male 9 pins SUB-D connector reference **220029P0020**  
SUB-D cover reference **220029P0039**  
Pins reference **220029P0021**

#### **Cable arrangement :**

EX terminals	Identification	Wire colour	SUB-D terminals
1	Us	Green	2
2	Gnd	Black (Black/ Green pair)	1
3	refSin	Blue	4
4	refCos	Black (Black/White pair)	7
5	Data +	Red	9
6	Data -	Black (Black/Red pair)	5
7	Sin +	Black (Black/Blue pair)	8
8	Cos +	White	3

### 3.10.9. Feedback cable reference

For other drive, you can assembly cable and plug by soldering with part number on the tab below:

Feedback Sensor	Cable reference (C2 / 100°C)
Resolver	6537P0059
Hiperface Encoder	
EnDat Encoder	

### 3.10.10. Power cable for AC890

Cable reference :

**CS4UQ1D1R0xxx** for current  $\leq 12\text{Amps}$

**CS4UQ2D1R0xxx** for current  $\leq 24\text{Amps}$

Power cable **6537P0057**

Power cable **6537P0058**



Cable arrangement :

EX terminals	Identification	Wire colour	Markings with labels on wires
U	U phase	Black 1	U
V	V phase	Black 2	V
W	W phase	Black 3	W
	Ground	Green/Yellow	
Br+	Brake +	Black 5	B +
Br-	Brake -	Black 6	B -
TH+	Thermal sensor +	Black 7	T+
TH-	Thermal sensor -	Black 8	T -

### 3.10.11. Power cable for COMPAX3

Cable reference :

**CC3UQ1D1R0xxx** for current  $\leq 12\text{Amps}$

**CC3UQ2D1R0xxx** for current  $\leq 24\text{Amps}$

Power cable **6537P0057**

Power cable **6537P0058**

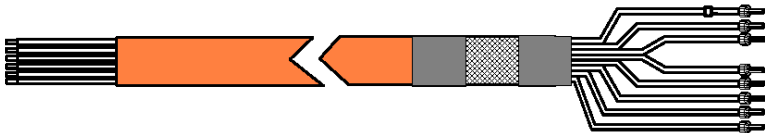

Cable arrangement :

EX terminals	Identification	Wire colour	Markings with labels on wires
U	U phase	Black 1	U
V	V phase	Black 2	V
W	W phase	Black 3	W
	Ground	Green/Yellow	
Br+	Brake +	Black 5	B +
Br-	Brake -	Black 6	B -
TH+	Thermal sensor +	Black 7	T+
TH-	Thermal sensor -	Black 8	T -

### 3.10.12. Power cable for SLVD

Cable reference :

**CS5UQ1D1R0xxx** for current  $\leq 12\text{Amps}$

**CS5UQ2D1R0xxx** for current  $\leq 24\text{Amps}$

Power cable **6537P0057**

Power cable **6537P0058**



**Cable arrangement :**

EX terminals	Identification	Wire colour	Markings with labels on wires
U	U phase	Black 1	U
V	V phase	Black 2	V
W	W phase	Black 3	W
	Ground	Green/Yellow	
Br+	Brake +	Black 5	B +
Br-	Brake -	Black 6	B -
TH+	Thermal sensor +	Black 7	T+
TH-	Thermal sensor -	Black 8	T -

### 3.10.13. Power cable for 637/638

Cable reference :

**CS2UQ1D1R0xxx** for current  $\leq 12\text{Amps}$

**CS2UQ2D1R0xxx** for current  $\leq 24\text{Amps}$

Power cable **6537P0057**

Power cable **6537P0058**

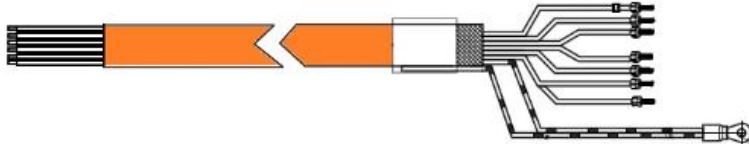

**Cable arrangement :**

EX terminals	Identification	Wire colour	Markings with labels on wires
U	U phase	Black 1	U
V	V phase	Black 2	V
W	W phase	Black 3	W
	Ground	Green/Yellow	
Br+	Brake +	Black 5	B +
Br-	Brake -	Black 6	B -
TH+	Thermal sensor +	Black 7	T+
TH-	Thermal sensor -	Black 8	T -

### **3.10.14. Power cable reference**

For other drive, you can assembly cable and plug by soldering with part number on the tab below:

<b>Ampacity</b>	<b>Cable reference (C2 / 100°C)</b>
Current $\leq$ 12Amps @40°C Current $\leq$ 9Amps @60°C	6537P0057
Current $\leq$ 24Amps @40°C Current $\leq$ 17Amps @60°C	6537P0058

### 3.11. Brake option



**Caution:** The holding brake is used to completely immobilize the servomotor under load. It is not designed to be used for repeated dynamic braking ; dynamic braking must only be used in the case of an emergency stop and with a limited occurrence depending on the load inertia and speed.

The standard brake power supply is 24 Vcc DC  $\pm$  10%.

Follow the polarity and the permissible voltage, and use shielded cables.

A 220  $\mu$ F capacitor avoids untimely braking if the 24 V voltage is disturbed by the external relay. Check the voltage value once this capacitor has been fitted. The RC network (220  $\Omega$ , 0.1  $\mu$ F) is needed to eliminate interference produced by the brake coil.

Position the contactor in the DC circuit to reduce brake response times. Follow the connection instructions taking the brake polarisation into account.

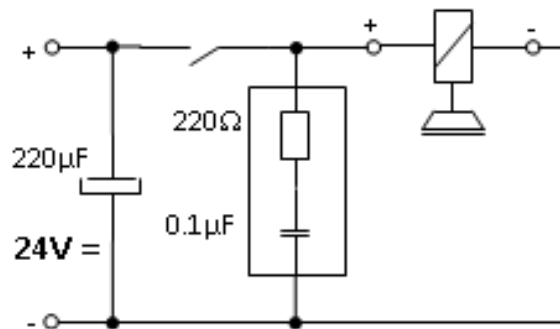

Motor	Static torque @20°C (N.m)	Static torque @100°C (N.m)	Power (W)	Engaging time (ms)	Disengaging time (ms)	Extra Inertia (Kg.m <sup>2</sup> .10 <sup>-5</sup> )	Angular backlash (°)
EX3	2	1.8	11	13	25	0.68	0
EX4	5.5	4	12	17	35	1.8	0
EX6	12	8	18	28	40	5.4	0
EX8	36	32	26	45	100	55.6	0

Table with typical values



## 4. COMMISSIONING, USE AND MAINTENANCE

### 4.1. Instructions for commissioning, use and maintenance

#### 4.1.1. Equipment delivery

All servomotors are strictly controlled during manufacturing, before shipping. While receiving it, it is necessary to verify motor condition and if it has not been damaged in transit. Remove it carefully from its packaging. Verify that the data written on the label are the same as the ones on the acknowledgement of order, and that all documents or needed accessories for user are present in the packaging.



Warning: In case of damaged material during the transport, the recipient must **immediately** make reservations to the carrier through a registered mail within 24 h..

#### 4.1.2. Handling

The servomotors EX8 are equipped with two lifting rings intended for handling.



Caution: Use only servomotors lifting rings, if present, or slings to handle the motor. Do not handle the motor with the help of electrical cables, connectors and water inputs/outputs, or use any other inappropriate method.

The drawings below show the correct handling procedure.

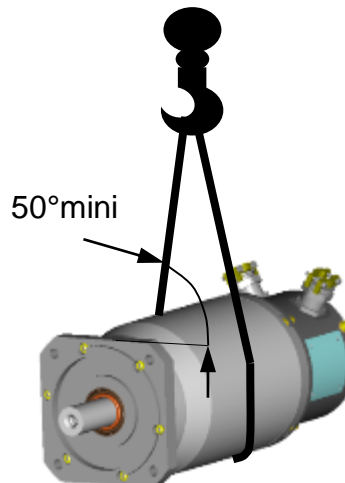

DANGER: Choose the correct slings for the motor weight. The two slings must be the same length and a minimum angle of  $50^\circ$  has to be respected between the motor axis and the slings.

### 4.1.3. Storage

Before being mounted, the motor has to be stored in a dry place, without rapid or important temperature variations in order to avoid condensation.

During storage, the ambient temperature must be kept between -20 and +60°C.

If the torque motor has to be stored for a long time, verify that the shaft end, feet and the flange are coated with corrosion proof product.

After a long storage duration (more than 3 month), run the motor at low speed in both directions, in order to blend the bearing grease spreading.

## 4.2. Installation

### 4.2.1. Mounting

Foundation must be even, sufficiently rigid and shall be dimensioned in order to avoid vibrations due to resonance. Before bolting the motor, the foundation surface must be cleaned and checked in order to detect any excessive height difference between the motor locations. The surface variation shall not exceed 0,1 mm. In all cases, we recommend using shims in order to compensate small irregularities.



Caution: The user bears the entire responsibility for the preparation of the foundation.

### 4.2.2. Torque value for the screws

The table below gives the average tightening torques required regarding the fixing screw diameter. These values are valid for both motor's feet and flange bolting.

Screw diameter	Tightening torque
M2 x 0.35	0.35 N.m
M2.5 x 0.4	0.6 N.m
M3 x 0.5	1.1 N.m
M3.5 x 0.6	1.7 N.m
M4 x 0.7	2.5 N.m
M5 x 0.8	5 N.m
M6 x 1	8.5 N.m
M7 x 1	14 N.m
M8 x 1.25	20 N.m

Screw diameter	Tightening torque
M9 x 1.25	31 N.m
M10 x 1.5	40 N.m
M11 x 1.5	56 N.m
M12 x 1.75	70 N.m
M14 x 2	111 N.m
M16 x 2	167 N.m
M18 x 2.5	228 N.m
M20 x 2.5	329 N.m
M22 x 2.5	437 N.m
M24 x 3	564 N.m





Warning: After 15 days, check all tightening torques on all screw and nuts.

### 4.2.3. Preparation

Once the motor is installed, it must be possible to access the wiring, and read the manufacturer's plate. Air must be able to circulate around the motor for cooling purposes. Clean the shaft using a cloth soaked in white spirit or alcohol. Pay attention that the cleaning solution does not get on to the bearings.

The motor must be in a horizontal position during cleaning or running.

	<p><u>Caution:</u> Do not step on the motor or the cable glands.</p>
	<p><u>Caution:</u> Always bear in mind that some parts of the surface of the motor can reach a temperature of 135°C</p>

### 4.2.4. Mechanical assembly

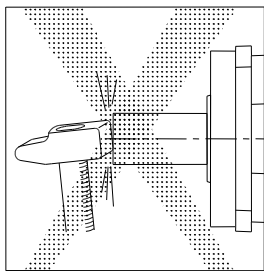

The operation life of servomotor bearings depends largely on the care and attention given to this operation.

- In the event that the servomotor shaft has a cotter pin, make sure that the coupling components have been balanced correctly without the cotter pin, the servomotor having been balanced with its cotter pin.

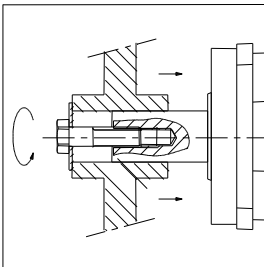

- Prohibit any impact on the shaft and avoid press fittings which could mark the bearing tracks. If press fitting cannot be avoided, it is advisable to immobilize the shaft in motion; this solution is nevertheless dangerous as it puts the resolver at risk.

- Use the thread at the end of the shaft in accordance with the diagram for fitting pulleys or accessories. It is possible to put pressure on the shoulder of the shaft located in front of the bearing.

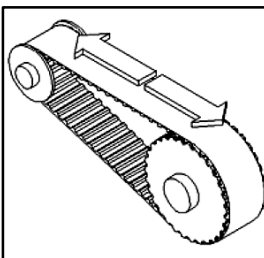



- In the event that the front bearing block is sealed by a lip seal which rubs on the rotating section (version IP 65), we recommended that you lubricate the seal with grease thus prolonging its operational life.

- In the event that the drive system uses a pulley and belt, the drive pulley must be fixed as close as possible to the flange. The pulley diameter is to be selected so that the radial load does not exceed the limits given in the catalog.





- CAUTION: Any equipment such as gearbox, mechanical speed drives, brakes, forced ventilation, integrated frequency converters, sensors, actuators, etc. associated with the motor must also have ATEX certification.

	<p>Warning : a misalignment of the coupling device makes stress and load on the motor shaft depending the rigidity of the installation. The variations of the temperature makes stress and load due to the dilatation. These loads (axials and radiale) do not exceed the load written (§ 3.5).</p>
	<p><u>Warning</u> : The misalignment of the coupling device makes vibration who can realize a destruction of the motor shaft.</p>
	<p>We cannot be held responsible for wear on the drive shaft resulting from excessive strain.</p>

### 4.3. Electrical connections

---

	<p><u>Danger</u>: Check that the power to the electrical cabinet is off prior to making any connections.</p>
--	--

	<p><u>Caution</u>: The wiring must comply with the drive commissioning manual and with recommended cables.</p>
---	--

	<p><u>Danger</u>: The motor must be earthed by connecting to an unpainted section of the motor.</p>
---	---

	<p><u>Caution</u>: After 15 days, check all tightening torques on cable connection.</p>
---	---



### 4.3.1. Cable connection

Please, read §3.8 "Electrical connection" to have information about cable connection  
Many useful informations are already available in the drive documentations.

### 4.3.2. Encoder cable handling

	<p><u>Danger:</u> before any intervention the drive must be stopped in accordance with the procedure.</p>
---	---

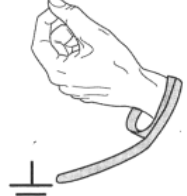
	<p><u>Caution:</u> It is forbidden to disconnect the Encoder cable under voltage (high risk of damage and sensor destruction).</p>
---	--

	<p><u>Warning:</u> Always wear an antistatic wrist strap during encoder handling.</p>
	<p><u>Warning:</u> Do not touch encoder contacts (risk of damage due to electrostatic discharges ESD).</p>

### 4.3.3. Connection diagrams

#### 4.3.3.1. EX3-EX4 DC supply

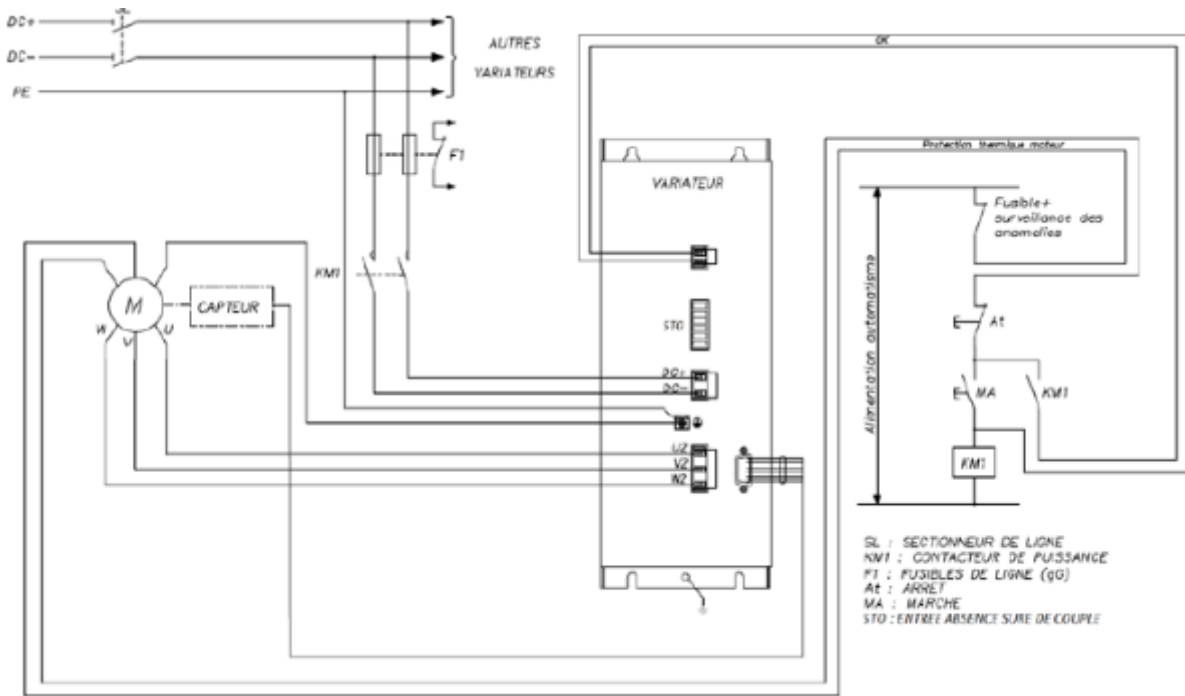

#### 4.3.3.2. EX single phase

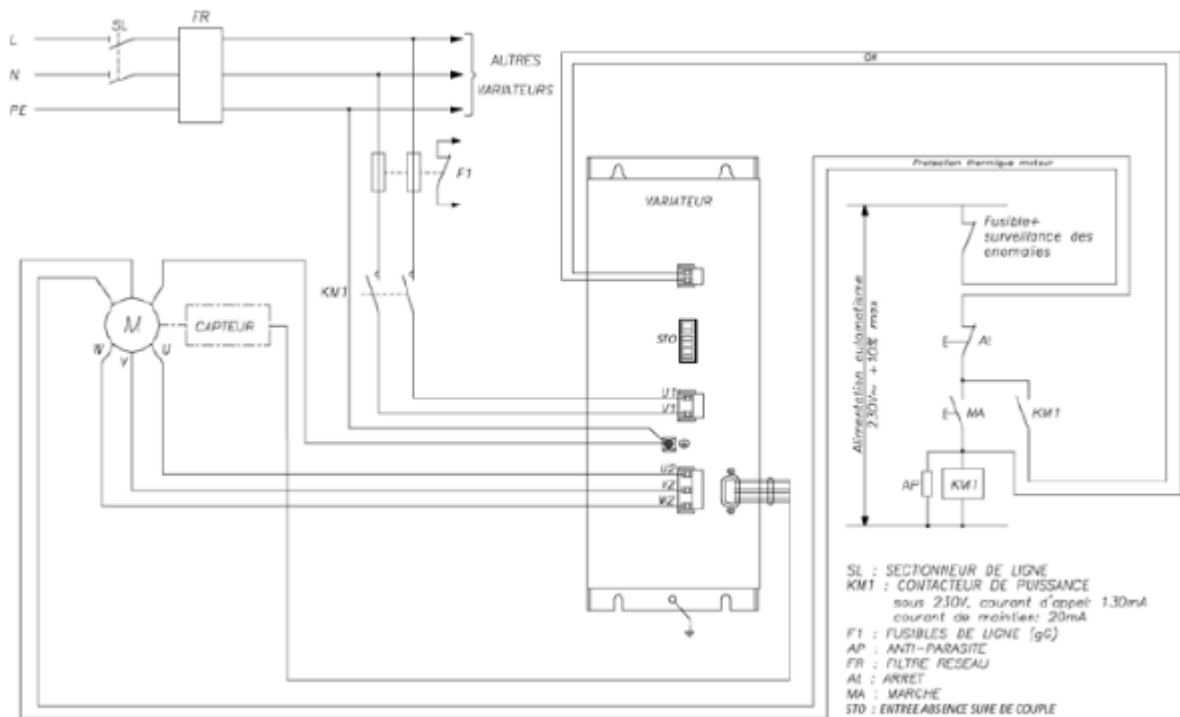

### 4.3.3.3. EX three phase

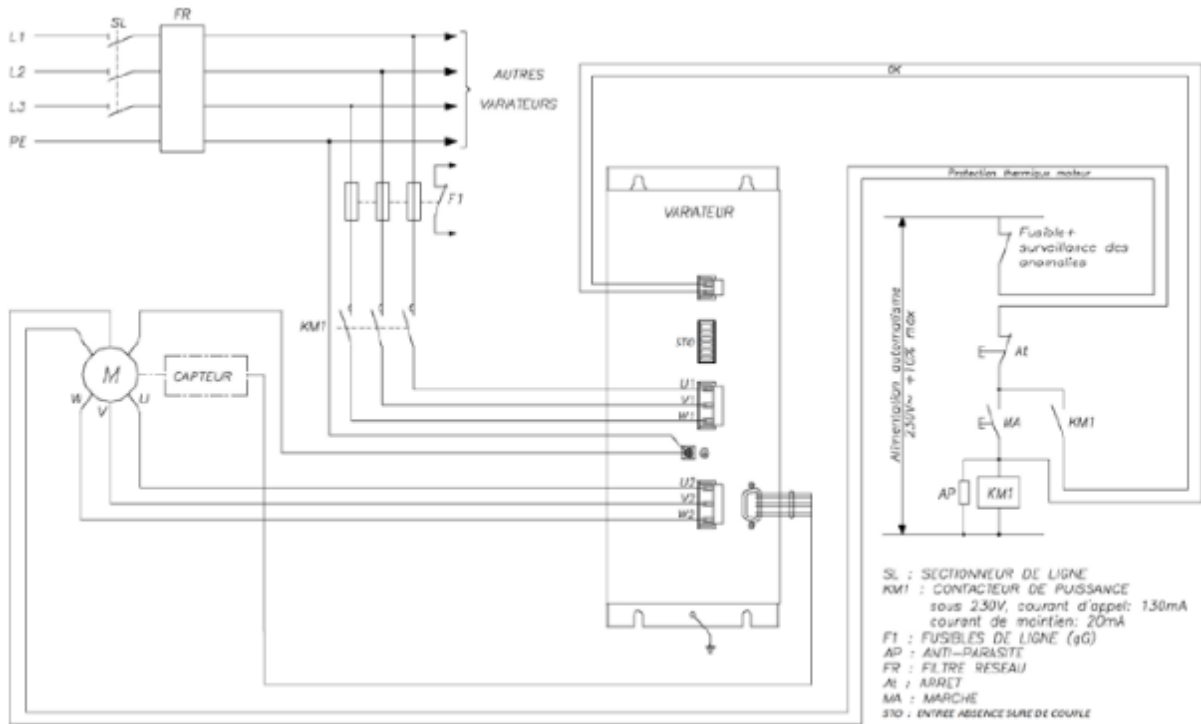

The safe torque off function is an alternative solution for the motor temperature monitoring.

The safe torque off function in accordance with the standards EN ISO 13849-1 : 2006 and EN 61800-5-2 : 2006 is an electronic system set up on some drives certified by a notified body. This is an unlocked input placed on the drive that must be connected (see the commissioning and use manual of the drive).

The servomotors EX are equipped with a thermal protection which is checked by a safety analysis and is a key element of the ATEX/IECEx safety. It is possible to connect this protection to the unlocked input or through a safety system in accordance to the drive specifications. This connection allows to maintain the drive power on, but disable the motor after the activation of the thermal protection.

After an activation of this security device, the system must not restart automatically and without a checking of the installation.

In all cases, the connection of this device must be checked and certified by a notified body.

### 4.3.4. Cable glands informations (Only ATEX/IECEx)

#### 4.3.4.1. Technical data

**ADE - 1F2 ISO**



Type	ADE-1F2 (not for Mining application)
Certified	Ex: Ineris - Cepel - Gost-R - Nepsi - UL IIII Shipping: ABS - DNV - Lloyd's
Size	n°3 to n°17 for cable external diameter from 2,75 to 104mm Thread sizes M10 to M110 inclusive UL thread size M20 to M110 inclusive
Cable type	Unarmored cable and Marine Shipboard cable. Instrumentation-Tray-Cable (ITC), Medium Voltage (MV), Power-Limited-Tray-Cable (PLTC) and Tray Cable (TC).
Clamping	By sealing ring (25%), the user shall provide additional clamping of the cable.
Standard material	Nickel Plated Brass
Alternative material	Stainless-steel, Bronze or Aluminum.
Service Temperature	From -30 to +80°C with Neoprene sealing ring From -60 to +140°C with Silicone sealing ring
Fixing to equipment	Metric according to ISO 965-1 & 965-3
Thread Lubricant / Sealer	STL2 (2oz) or STL8 (8oz) ; Temperature range -20°F to +200°F ≈ -30°C to +95°C HTL4 (4oz) ; Temperature range -70°F to +1800°F ≈ -60°C to +1000°C
IP rating:	- On equipment with threaded hole and contact surface roughness Ra 1.6 µm maxi: * IP66 without added gasket. * IP68 tested 30m/7days with Capri qualified Fiber-Gasket. - On equipment with blank hole (not for "d" use), fixed with Capri qualified looknut, all the threads must be engaged: * IP66 depending to the flatness and the roughness of the contact surface of the enclosure: . Without added gasket for Ra 0.4 µm maxi. . With Capri qualified Fiber-Gasket for Ra 1.6 µm maxi. * IP68 tested 30m/7days with Capri qualified Fiber-Gasket for Ra 1.6 µm maxi roughness of the contact surface. - The length of the threaded entry permit to meet the applicable thread engage, also with the add of gasket between the cable gland and the enclosure (gasket thickness 1,5 or 2mm).
Deluge Compliance	DTS-01.91
ATEX Standards	INERIS: INERIS12ATEX0032X EN 60079-0:2009, EN 60079-1:2007, EN 60079-7:2007, EN 60079-15:2010, EN 60079-31:2009.
Marking code	Ⓔ II2GD / Ex db IIC / Ex eb IIC / Ex tb IIIC IP66
Zones & Use	Ⓔ II3G Ex nRc IIC Zones 1 & 2 ; Groups IIA, IIB and IIC ; for use "d", "e", "ia", "ib", "ic", "ma", "mb", "mo", "nA", "nC", "nR", "o", "pv", "px", "py", "pz" & "q". Zones 21 & 22 ; Groups IIIA, IIIB and IIIC ; for use "ib", "ic", "ia", "ib", "ma", "mb", "mc" & "p".
IECEx Standards	INERIS: IECEx INE 12.0025X IEC 60079-0:2011, IEC 60079-1:2007, IEC 60079-7:2006, IEC 60079-15:2010, IEC 60079-31:2008
Marking code	Ex db IIC / Ex eb IIC / Ex nRc IIC / Ex tb IIIC IP66
Other Ex Certificates	CEPEL (Inmetro): CEPEL 05.0558X GOST-R: POCC FR.ΓE05B03126 N°0422515 NEPSI: GYJ13.1082X
Shipping Certificates	ABS Manufacturing & Design Assessment P1836754-X & 10-HS 577243-PDA DNV Type Approval certificate N° E-10892 Lloyd's Type Approval certificate N° 11/00072
	cULus: E310130 UL 514B, UL 2225 and C22.2 No 1 with respect to the US National Electrical Code (NEC) and Canadian Electrical Code (CEC). Class I, Zone 2, AEx e II, Ex e II Hazardous Areas for use with unarmored ITC, MV, PLTC & TC cable. Allow installation in all gas atmospheres Article 505 of the NEC and section 18 of CEC.
	cULus: E314047 UL 514B, UL 2225 and C22.2 No 1 with respect to the US National Electrical Code (NEC) and Canadian Electrical Code (CEC). Class I, Zone 2, AEx e II, Ex e II Hazardous Areas for use with unarmored marine shipboard cable. Allow installation in all gas atmospheres Article 505 of the NEC and section 18 of CEC.



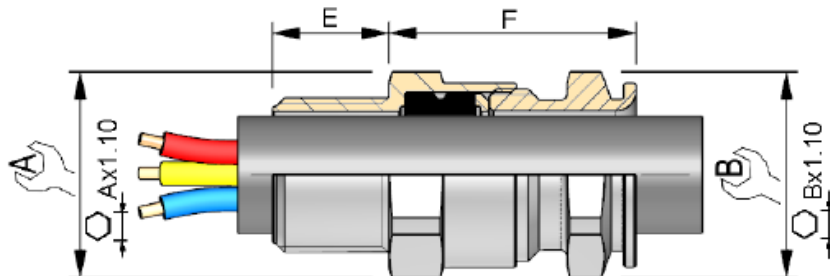

Reference CW614N / CR	Reference CW614N / SI	Reference 316 L / CR	Reference 316 L / SI	ISO mini	ADE N°	Ø Externe Cable External Ø	A	B	E	F maxi
CAP806404V1	CAP806405V1	CAP806409V1	CAP806406V1	12*	4	4,5-8	17	17	15	25
CAP806594V1	CAP806595V1	CAP806599V1	CAP806596V1	16*	4	4,5-8,5	19	17	15	25
CAP806504V1	CAP806505V1	CAP806509V1	CAP806506V1	16*	5	7-12	19	19	15	27,5
CAP806664V1	CAP806665V1	CAP806669V1	CAP806666V1	20	3	2,75-5,5	24	15	15	24
CAP806674V1	CAP806675V1	CAP806679V1	CAP806676V1	20	4	4,5-8,5	24	17	15	25
CAP806694V1	CAP806695V1	CAP806699V1	CAP806696V1	20	5	7-12	24	19	15	27,5
CAP806604V1	CAP806605V1	CAP806609V1	CAP806606V1	20	6	10- 16	24	24	15	32
CAP806774V1	CAP806775V1	CAP806779V1	CAP806776V1	25	5	7-12	30	19	15	27,5
CAP806794V1	CAP806795V1	CAP806799V1	CAP806796V1	25	6	10-16	30	24	15	32
CAP806704V1	CAP806705V1	CAP806709V1	CAP806706V1	25	7	13,5-20,5	30	30	15	36,5
CAP806804V1	CAP806805V1	CAP806809V1	CAP806806V1	32	8	18-27,5	41	41	15	46
CAP806904V1	CAP806905V1	CAP806909V1	CAP806906V1	40	9	23-34	48	48	15	50
CAP807004V1	CAP807005V1	CAP807009V1	CAP807006V1	50	10	29-41	55	55	16	52
CAP807084V1	CAP807085V1	CAP807089V1	CAP807086V1	50	11	35-45	64	64	16	56,5
CAP807204V1	CAP807205V1	CAP807209V1	CAP807206V1	63	12	42-56	72	72	17	60
CAP807304V1	CAP807305V1	CAP807309V1	CAP807306V1	75	13	50-65	85	85	18	67,5
CAP807594V1	CAP807595V1	CAP807599V1	CAP807596V1	90	14	58-74	95	95	22	69
CAP807504V1	CAP807505V1	CAP807509V1	CAP807506V1	90	15	66-83	110	110	22	80
CAP807604V1	CAP807605V1	CAP807609V1	CAP807606V1	110	16	75- 93	120	120	22	80
CAP807704V1	CAP807705V1	CAP807709V1	CAP807706V1	110	17	85-104	135	135	22	90

\*Non UL

### 4.3.4.2. Torque value

#### M16 Cable glands ADE N°5 :

Torque value for the cap = 12,5 N.m

Torque value for the connection module = 0,5 N.m

#### M20 Cable gland ADE N°6 :

Torque value for the cap = 20 N.m

Torque value for the connection module = 0,5 N.m

### 4.3.5. UL Electrical commissioning

	<p>The cables (Feedback or power cable) is a choice for end user and must be conform local state regulations.</p>
	<p>The end user will comply with local state regulations for his installation and he will make the UL certification for his installation</p>
	<p>The end user will determine which kind of connections and/ or conduits will be used.</p>
	<p><u>Warning</u> : Installers use any wiring other than that shown in the diagrams in §4.3.3. "Connection diagrams" at their own risk; Parker cannot be held responsible for unauthorized wiring. Make sure that the characteristics of the contactors shown in these diagrams are strictly followed according to the drive current</p>
	<p><u>CAUTION</u> : the drive associated with the motor must be outside the explosive area (hazardous area).</p>
	<p><u>Warning</u> : the conduit seal must be required within 18 inches of the motor.</p>



Connection of the UL motor:

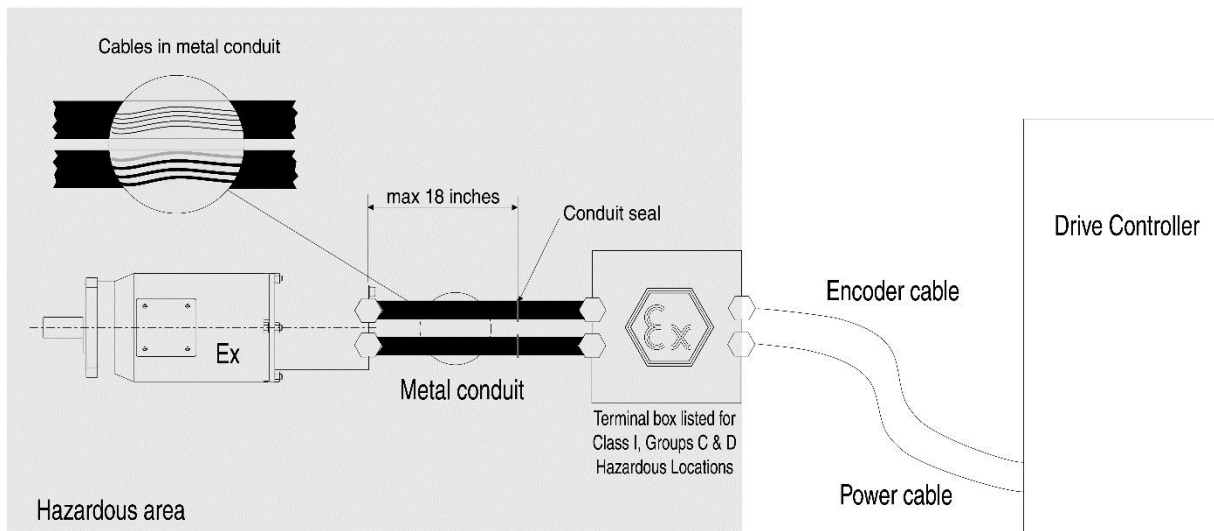



allowed Ex cable glands

Cable glands, metal pipes and terminal box not delivered

## 4.4. Maintenance Operations

### 4.4.1. Summary maintenance operations

	<p><b>Generality</b>  <b>DANGER:</b> The installation, commission and maintenance operations must be performed by qualified personnel, in conjunction with this documentation.</p> <p>The qualified personnel must know the safety (C18510 authorization, standard VDE 0105 or IEC 0364) and local regulations.</p> <p>They must be authorized to install, commission and operate in accordance with established practices and standards.</p> <p>Please contact PARKER for technical assistance.</p>
---	--

	<p><b>Danger:</b> before any intervention the motor must be disconnected from te power supply.          Due to the permanent magnets, a voltage is generated at the terminals when the motor shaft is turned</p>
---	--

### Special requirements for ATEX servomotors

	<p>If a screw assembly of the enclosure need to be replaced, the new screw will must be quality 8.8 or higher. For the EX8 in UL version the screw must be quality 14.9 or higher.</p>
---	--

	<p>If the motor is used in dust explosive atmospheres, do not forget to do a regular cleaning in order to avoid the deposits of dusts.</p>
---	--

Operation	Periodicity
Clean the motor	Every year
Motor inspection (vibration changes, temperature changes, tightening torques on all scews)	Every year
Cable inspection, no degradation (colour, flexibility, cracks...)	Every year
Bearing replacement	Every 20 000h

#### **4.4.2. Informations about the flameproof enclosure components**

The Ex motors of Parker Hannifin France has a traceability on the flameproof enclosure components. It is forbidden to replace on of these components without consulting Parker Hannifin.

If a cover exchange between two identical motors is required, the customer must make a new traceability on these components. To make the traceability, the customer must refer to the number written on the cover.

#### **4.4.1. ATEX flameproof joints informations ATEX/IECEx**

In accordance with the standards for explosive atmospheres, find below the detail of the ATEX/IECEx flameproof joints

##### **Size EX3 :**

Flameproof joints	Joint length	Joint gap
Joint between the shaft and the housing	9,5 mm min	0,245 mm Max
Joint between the housing and the rear flange	13,4 mm min	0,177 mm Max
Joint between the rear flange and the cover	12,7 mm min	0,087 mm Max

##### **Size EX4 :**

Flameproof joints	Joint length	Joint gap
Joint between the shaft and the front flange	12,5 mm min	0,239 mm Max
Joint between the front flange and the housing	14,3 mm min	0,059 mm Max
Joint between the housing and the rear flange	12,9 mm min	0,069 mm Max
Joint between the rear flange and the cover	12,9 mm min	0,106 mm Max

##### **Size EX6 :**

Flameproof joints	Joint length	Joint gap
Joint between the shaft and the front flange	12,5 mm min	0,239 mm Max
Joint between the front flange and the housing	13,7 mm min	0,069 mm Max
Joint between the housing and the rear flange	13,4 mm min	0,069 mm Max
Joint between the rear flange and the cover	13,42 mm min	0,069 mm Max

##### **Taille EX8 :**

Flameproof joints	Joint length	Joint gap
Joint between the shaft and the end flange	12,5 mm min	0,178 mm Max
Joint between the end flange and the front flange	16,7 mm min	0,007 Max
Joint between the front flange and the housing	12,7 mm min	0,079 mm Max
Joint between the housing and the rear flange	13,5 mm min	0,079 mm Max
Joint between the rear flange and the cover	14,1 mm min	0,146 mm Max

## 4.5. Troubleshooting

Some symptoms and their possible causes are listed below. This list is not comprehensive. Whenever an operating incident occurs, consult the relevant servo drive installation instructions (the troubleshooting display indications will help you in your investigation) or contact us at: <http://www.parker.com/eme/repairservice>.

<p>You note that the motor does not turn by hand when the motor is not connected to the drive.</p>	<ul style="list-style-type: none"> <li>• Check there is no mechanical blockage or if the motor terminals are not short-circuited.</li> <li>• Check the power supply to the brake.</li> </ul>
<p>You have difficulty starting the motor or making it run</p>	<ul style="list-style-type: none"> <li>• Check on the fuses, the voltage at the terminals (there could be an overload or the bearings could be jammed), also checks on the load current.</li> <li>• Check the power supply to the brake (+ 24 V <math>\pm</math> 10 %) and its polarity.</li> <li>• Check on any thermal protection, its connection and how it is set in the drive.</li> <li>• Check on the servomotor insulation (if in doubt, carry out hot and cold measurements).</li> </ul> <p>The minimum insulation resistance value measured under a max. 50V DC is 50 M<math>\Omega</math>:</p> <ul style="list-style-type: none"> <li>• Between the phase and the casing</li> <li>• Between the thermal protection and the casing</li> <li>• Between the brake coil and the casing</li> <li>• Between the resolver coils and the casing.</li> </ul>
<p>You find that the motor speed is drifting</p>	<ul style="list-style-type: none"> <li>• Reset the offset of the servoamplifier after having given a zero instruction to the speed setpoint input.</li> </ul>
<p>You notice that the motor is racing</p>	<ul style="list-style-type: none"> <li>• Check the speed setpoint of the servo drive.</li> <li>• Check you are well and truly in speed regulation (and not in torque regulation).</li> <li>• Check the encoder setting</li> <li>• Check on the servomotor phase order: U, V, W</li> </ul>
<p>You notice vibrations</p>	<ul style="list-style-type: none"> <li>• Check the encoder and tachometer connections, the earth connections (carefully) and the earthing of the earth wire, the setting of the servo drive speed loop, tachometer screening and filtering.</li> <li>• Check the stability of the secondary voltages.</li> <li>• Check the rigidity of the frame and motor support..</li> </ul>
<p>You think the motor is becoming unusually hot</p>	<ul style="list-style-type: none"> <li>• It may be overloaded or the rotation speed is too low : check the current and the operating cycle of the motor.</li> <li>• Check if the mounting surface is enough or if this surface is not a heat source – see §3.6 cooling.</li> <li>• Friction in the machine may be too high :             <ul style="list-style-type: none"> <li>- Test the motor current with and without a load.</li> <li>- Check the motor does not have thermal insulation.</li> <li>- Check that there is no friction from the brake when the brake power is on.</li> </ul> </li> </ul>



<p>You find that the motor is too noisy</p>	<p>Several possible explanations :</p> <ul style="list-style-type: none"><li>• Unsatisfactory mechanical balancing</li><li>• There is friction from the brake: mechanical jamming.</li><li>• Defective coupling</li><li>• Loosening of several pieces</li><li>• Poor adjustment of servo drive or position loop : check rotation in open loop</li></ul>
---	---



EMAC s.r.o.  
Kasarenska 2404/26  
911 05 Trencin  
SLOVAKIA

Parker certified distributor  
☎ +421 32 3810 232  
✉ [info@emac.sk](mailto:info@emac.sk)  
🌐 [www.emac.sk](http://www.emac.sk)