

DC Drives - Integrator Series

DC590+ Series 2

1A – 2700A

Description

The DC590+ Integrator Series 2 DC drive is the latest development of the range which also includes the AC690+ AC drives. It benefits from 30 years experience of designing and manufacturing drives for process line control with dedicated function blocks which simplify the implementation of applications such as sectional drive reels, winder control etc. The function block capabilities offer unparalleled

flexibility in both new installations and retrofit applications. A number of common fieldbus communications options enable connectivity to a wide range of popular control networks allowing the DC590+ to be integrated in larger control systems. The DC590+ is also available as a “ready to install” drive package called the DRV. This is a single integrated module that includes all associated power

components within the package. This innovative approach radically reduces design time, panel space, wiring time and cost. In addition the DRV minimises the risk of error associated with installing the drive. The DRV concept is unique and comes from the experience gained from thousands of successful applications across a diverse range of industries.



Common programming, set-up and communications platform with AC690+ AC Integrator Series

Ratings up to 2700A and supply voltages to 660V

Internal controlled field supply

Function blocks programming, including open and closed-loop winder control as standard

DRV option with built-in contactor, fuses and blower starter

Standards

The DC590+ series meets the following standards when installed in accordance with the relevant product manual.

CE marked to EN50178 (Safety, Low Voltage Directive) EN61800-3 (EMC Directive) with integral filters. External supply capacitors are required up to 110A for compliance.

- Supply Voltage 220-500V as standard
- CE marked
- UL an cUL approved up to 830A



DC Drives - Integrator Series

DC590+ Series 2

1A – 2700A

Next Generation Technology

Building upon the highly successful DC590+ drive used in thousands of applications world-wide, the DC590+ Integrator Series 2 drive takes DC motor control to the next level. With its state-of-the-art advanced 32-bit control architecture, the DC590+ drive delivers highly functional and flexible control suited to a whole host of industrial applications.

Typical Applications

- Converting machinery
- Plastics and rubber processing machinery
- Wire and cable
- Material handling systems
- Automotive

Function Block Programming

Function Block Programming is a tremendously flexible control structure that allows an almost infinite combination of user functions to be realised with ease. Each control function (an input, output, process PID for example) is represented as a software block that can be freely interconnected to all other blocks to provide any desired action.

The drive is despatched with the function blocks pre-configured as a standard DC drive so you can operate it straight from the box without further adjustments. Alternatively you can pick pre-defined Macros or even create your own control strategy, often alleviating the need for an external PLC and therefore reducing cost.

Feedback Options

The DC590+ has a range of interface options which are compatible with the most common feedback devices enabling simple

motor control through to the most sophisticated multi-motor system. Armature voltage feedback is standard without the need for any interface option.

- Analogue tachogenerator
- Encoder
- Optical fibre microtech encoder

Interface Options

Designed with connectivity in mind, the DC590+ has a number of communications and I/O options that allow the drive to take control of the application, or be integrated into a larger system. When combined with function programming, custom functions and control can be easily created offering the user a highly flexible and versatile platform for DC motor control.

Programming/Operator Controls

Featuring an intuitive menu structure, the ergonomically designed operator panel allows quick and easy access to all parameters and functions of the drive via a bright, easy to read backlit display and tactile keypad. Additionally, it provides local control of start/stop, speed demand and rotation direction to greatly assist with machine commissioning.

- Multi-Lingual alpha-numeric display
- Customised parameter values and legends
- On drive or remote mounting
- Local control of start/stop, speed and direction
- Quick set-up menu

Connectivity

Whatever the complexity of your control scheme, the DC590+ has the interface to suit. As standard there's enough analogue and digital I/O for the most complex applications. Alternatively, add the relevant 'technology box' for immediate access to serial communications and Fieldbus networks. The DC590+ has been designed to fit seamlessly, and without compromise, into any control environment.

Analogue/Digital Control

- 5 Analogue Inputs (12bit + sign)
- 3 Analogue Outputs
- 9 Digital Inputs
- 3 Digital Outputs

Serial Communications and Fieldbus Options

- Profibus
- Canopen
- Lonworks
- RS422/RS485
- Controlnet
- Ei Bisynch
- Link
- Devicenet
- Modbus
- Ethernet



6901 Programming/Operator Controls

DC Drives - Integrator Series

DC590+ Series 2

Technical Specifications



Power configuration	DC590+ 4 quadrant regenerative; 2 fully controlled 3 phase thyristor bridges DC591+ 2 quadrant; 1 fully controlled 3 phase thyristor bridge
Armature rating (A _{dc})	Frame 1 15, 35A Frame 2 40, 70, 110, 165A Frame 3 180, 270A Frame 4 380, 500, 725, 830A Frame 5 1580A Frame 6 1250, 1600, 1950A Frame H 1200, 1700, 2200, 2700A DRV versions are only available in Frame sizes 1 and 2
Overload	15- 450A; 200% for 10 seconds 150% for 30 seconds - from 700A : several overload choices are available
Supply voltage (Vac) 50/60Hz	220-500V (±10%) Frame 1-5 110-220V (±10%) Option Frame 1-5 500-600V (±10%) Option Frame 4-5 380-600V (±10%) Frame 6 380-690V (±10%) Frame 6 500-690V (±10%) Frame H
Field current max	4A Frame 1 30A Frame 4 and 5 10A Frame 2 and 3 60A Frame H
Field voltage max	$V_{field} = V_{ac} \times 0.82$
Operating Environment	
Operating temperature	0-45°C (15-165A) 0-35°C (180-270A) 0-40°C (current ≥1200A) derate by 1%/°C up to 55°C max
Altitude	500m above sea level Derate by 1%/200m above 500m to 5000m max

DC Drives - Integrator Series

DC590+ Series 2

Features and Benefits

Easy to use operator controls

- Detailed diagnostics
- Multi-language display

Advanced autotuning

Standard open fieldbuses



Configurable input-output terminal blocks

- 5 analogue inputs
- 3 analogue outputs
- 9 digital inputs
- 3 digital outputs



Macro function blocks

- Open-loop winder control
- winder control - loadcell/dancer
- Section control
- Maths functions
- Embedded controller functions

Worldwide product support

The DC590+ DC Drive is available with full application and service support in over fifty countries worldwide. So wherever you are, you can be confident of full back up and support.



Rapid Commissioning, optimal control performance and easy maintenance

With its self-tuning algorithm, the DC590+ can be configured and commissioned within minutes, without turning the motor and without the need for high levels of engineering know-how
The operator interface allows easy monitoring of machine operation and simplifies maintenance.

Easy integration into existing control networks

The DC590+ has a wide choice of common industry fieldbus communication options allowing seamless integration into existing factory control networks

Interfacing with existing external control equipment (Dancer, gauge, etc...)

A number of input / output options gives the DC590+ the flexibility needed for integration into any variable speed system. Combined with its embedded automation functions, its input-output configurations can in many instances remove the need for an external PLC.

Years of applications expertise at your service

The DC590+ macro function blocks are the result of over 30 years of experience gained by Parker SSD of installing drives in variable speed and sectional drive systems. This unique application experience is included in the drive in the form of dedicated function blocks at no extra cost, thereby reducing the design costs of your machinery.



DC Drives - Integrator Series

DC590+ Series 2

Technical Specifications

Protection	High energy MOV's Heatsink overtemperature Instantaneous overcurrent Thyristor trigger failure Inverse time overcurrent Interline snubber network Field Failure Zero speed detection Speed feedback failure Stall protection Motor overtemperature Stall protection
Inputs/Outputs	
Analogue inputs	(5 Total - 1 x 12 bit plus sign, 4 x 10 bit plus sign) 1 - Speed demand setpoint (-10/0/+10V) 4 - Configurable
Analogue outputs	(3 Total - 10 bit) 1 - Armature current output (-10/0/+10V or 0-10V) 2 - Configurable
Digital inputs	(9 Total - 24V, max 15mA) 1 - Program stop 1 - Coast stop 1 - External stop 1 - Start/Run 5 - Configurable
Digital outputs	(3 Total - 24V(max 30V) 100mA) 3 - Configurable
Reference Supplies	1 - +10V dc 1 - -10V dc 1 - +24V dc

Dimensions

Current (A)	Frame	Dimensions (mm)			Weight (kg)
		W	H	D	
15/35	1	200	375	220	6.4
40/165	2	200	546	292	10.5
180/270	3	250	485	234	20
380/500	4	253	700	358	32
725/830					44
1580	5	506	700	358	90
1250/1950	6 2Q	686	715	378	95
	6 4Q				110
1200/1700	H 2Q	850	1406	417	270
2200/2700	H 4Q	850	956	417	160

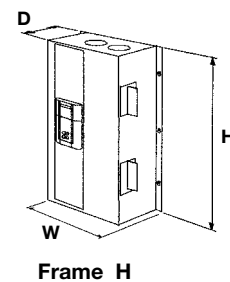
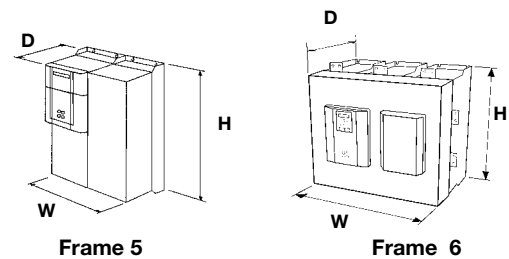
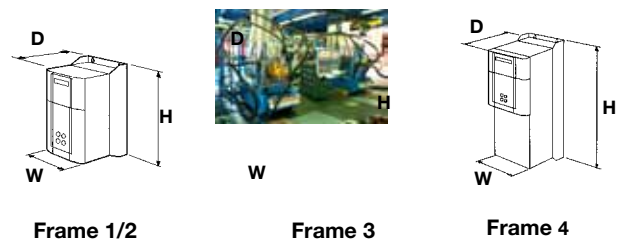

DC Drives - Integrator Series

590DRV Series - Ready to install

1A - 165A

The 590DRV is a ready to install version of the DC590+ DC Drive.

The DC590+ is available in either module, or alternatively "DRV" format up to 165A. The DRV includes all the peripheral power components associated with a DC drive system integrally fitted within the footprint of the drive. DRV options include the following integrally mounted within the drive:

- AC line contactor
- AC line fuses
- DC fuse (4 Quadrant regenerative version)
- Control / field fuses
- Motor blower starter

All of these options can be supplied pre-wired within the drive.

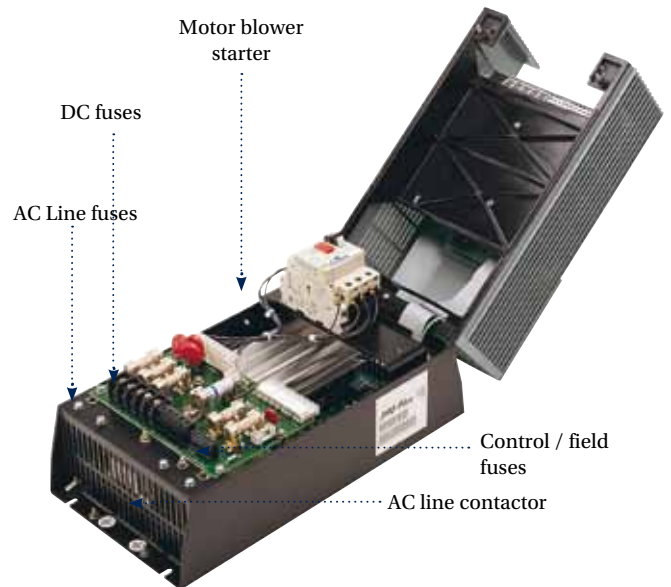

Advantages

- Simplified panel design
- Reduced component mounting and wiring
- Reduced design time
- Reduction of purchasing costs of individual components



Traditional DC drive section



DC590+ DRV equivalent illustrating panel space saving

DC590+ External Stack Controller

DC598+, DC599+ Series

The economical solution for retrofit applications

When upgrading machines equipped with older high power DC drives, the most cost-effective and quickest way is often to reuse the existing thyristor power stack, which in most cases will be in perfect working order.

To preserve your investment, Parker SSD Drives has developed a DC598+ / DC599+ power stack controller offer specially aimed at retrofit applications and based on the DC590+ controller.

Available in 2 versions, the DC599+ two quadrant non-regenerative and DC598+ four quadrant full-regenerative versions, can be used to drive the power stacks of existing DC drives manufactured by Parker SSD or other manufacturers, delivering the benefits of the recent technological innovations of the DC590+ Series 2 drive.

The DC598+ and DC599+ offer the ability to upgrade your equipment quickly and easily and integrates with your existing control equipment or SCADA package.

The DC598+ and DC599+ retrofit solutions are recommended for currents above 800A.



Benefits

- Reuse existing DC power stacks**
- Connectivity over standard common fieldbuses (Including Profibus, Ethernet, Devicenet, CANopen)**
- Easy to use operator interface**
- Flexible common Integrator Series programming environment.**
- Suitable for currents up to 2700A**



DC590+ External Stack Controller

DC598+, DC599+ Series

The DC598/9+ external stack controllers provide the following:

- Thyristor firing signals
- Thyristor firing pulse transformers
- AC current transformer feedback rectification and scaling
- Armature voltage feedback interface
- Coding and phase rotation interface
- Mains present monitoring
- Heatsink over-temperature input
- Field power modules and input/output terminals
- Field current monitoring and scaling
- All standard DC590+ I/O terminals

Technical Specifications

Supply Voltage	110-240Vac ±10% 3ph coding or 1ph power 220-500Vac ±10% 3ph coding or 1ph power 380-690Vac ±10% 3ph coding or 1ph power
Supply Frequency	50/60Hz ±10%
Output Field Current	60A DC naturally cooled - 120A DC force cooled (1 x Field Current DC value) Amps 1ph. AC Nominal 3ph AC
Field Output Voltage	(0.9 x 1ph Supply Voltage) V DC
Total Losses	(3 x idc out) Watts.
Auxiliary Supply	110-240Vac ±10% 1ph - Naturally cooled 110-120Vac ±10% 1ph - Force cooled 115V fan 220-240Vac ±10% 1ph - Force cooled 230V fan
Auxiliary Supply Current	SMPS Quiescent Current = 500mA 115Vac or 250mA 230Vac ie 50VA. Fan current - 270mA @ 115Vac or 135mA @ 230Vac
Auxiliary Supply Fuse	3 Amps
Operating Temp.	0 to +45°C
Storage Temp.	-25 to +55°C
Shipping Temp.	-25 to +70°C
Enclosure Rating	IP20
Altitude Rating	Maximum Altitude 500m De-rate the output at 1% per 200 meters
Humidity	Maximum 85% relative humidity at 45% non- condensing
Atmosphere	Non flammable, non-corrosive and dust free
Climatic	Class 3k3 as defined by EN60721-3-3 (1995)

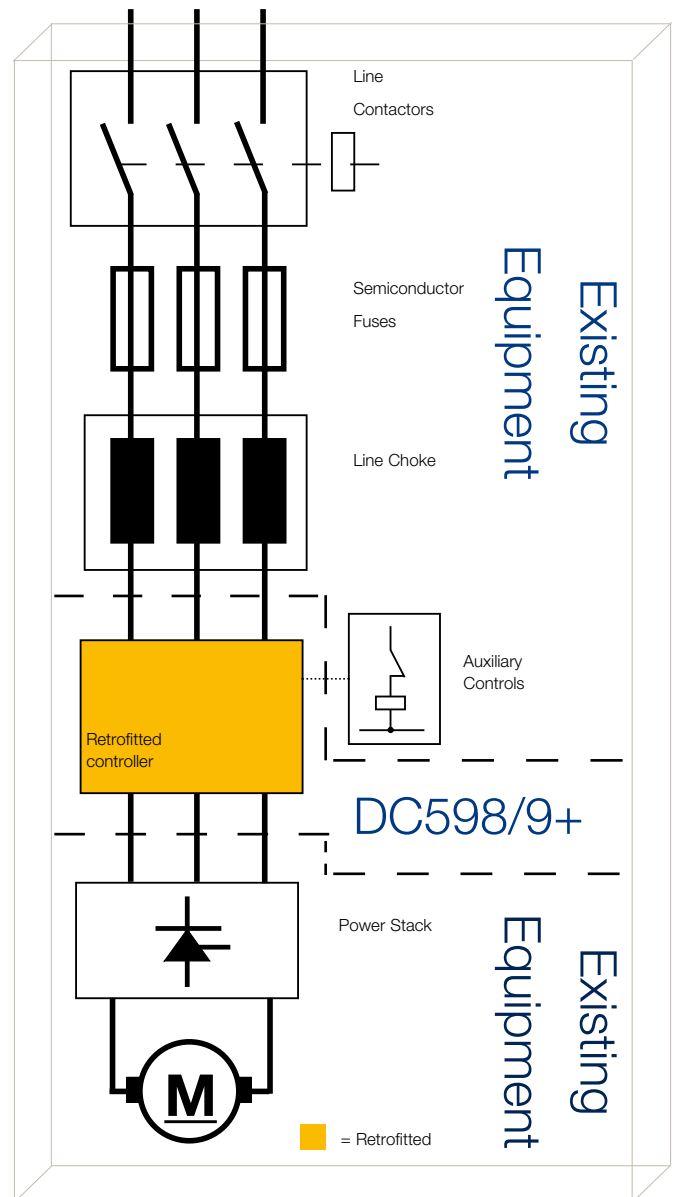

Standards

The DC598+ and DC599+ external stack controllers meet the requirements of EN50178 when mounted in an enclosure and also UL508C.

It is designed to meet Overvoltage category III and Pollution Degree 2

DC Drives - Integrator Series

DC590+ Integrator Series 2

Overview of Frames 1,2 and 3

1	Main drive assembly
2	Terminal cover
3	Terminal cover retaining screws
4	Blank cover
5	6901 keypad (optional)
6	COMMS technology box (optional)
7	Speed feedback technology card (optional)
8	Gland plate
9	Power terminal shield
10	Power terminals
11	Control terminals
12	Earthing points
13	Keypad port
14	RS232 programming port
15	Auxiliary power, external contactor and isolated thermistor terminals

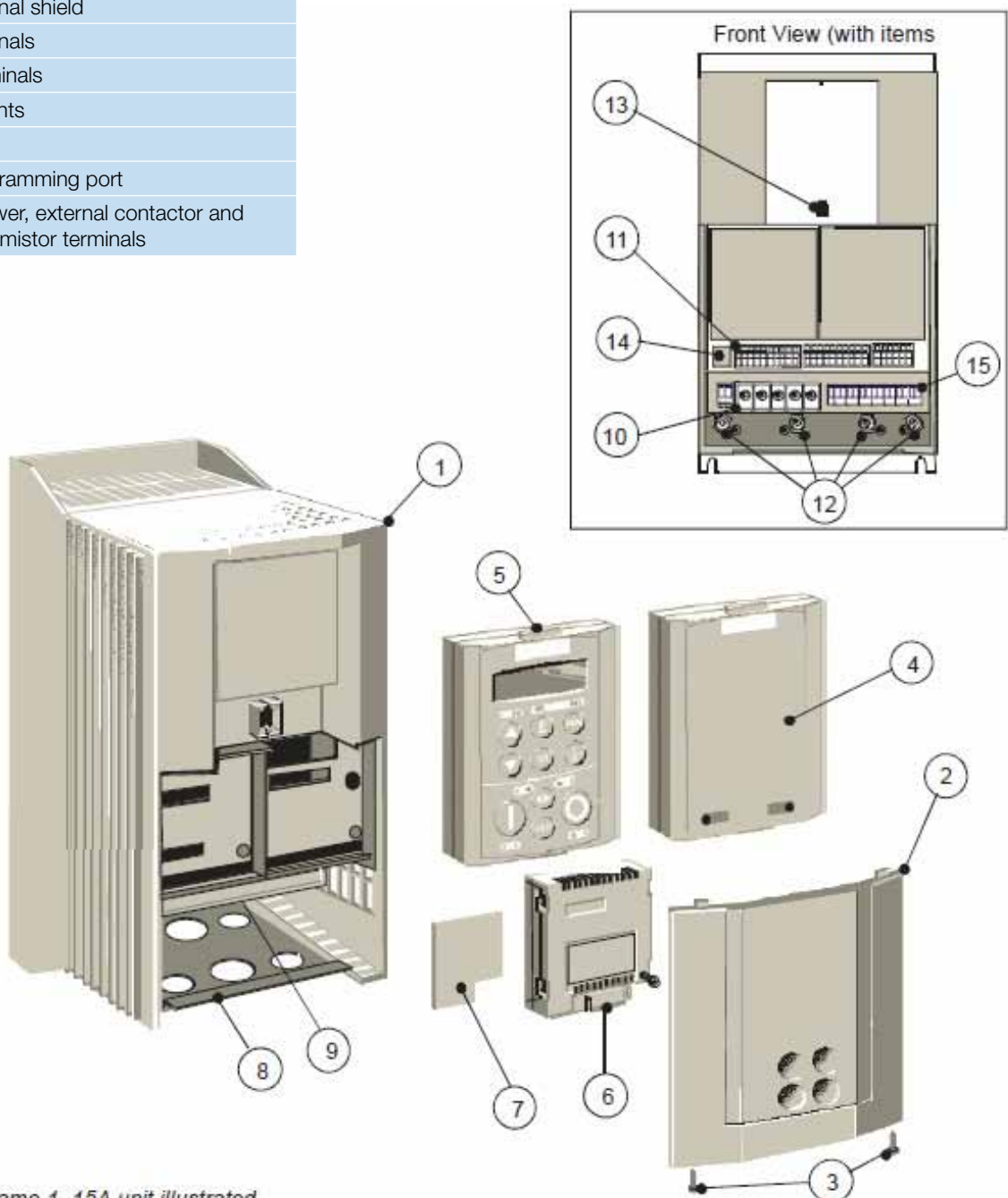

Frame 1, 15A unit illustrated

DC Drives - Integrator Series

DC590+ Integrator Series 2

Overview of Frame 3

1	Main drive assembly
2	Door assembly
3	Field wiring terminals
4	Busbars - main power input
5	Busbars - main power output
6	IP20 Top cover
7	IP20 Fan housing (where fitted)

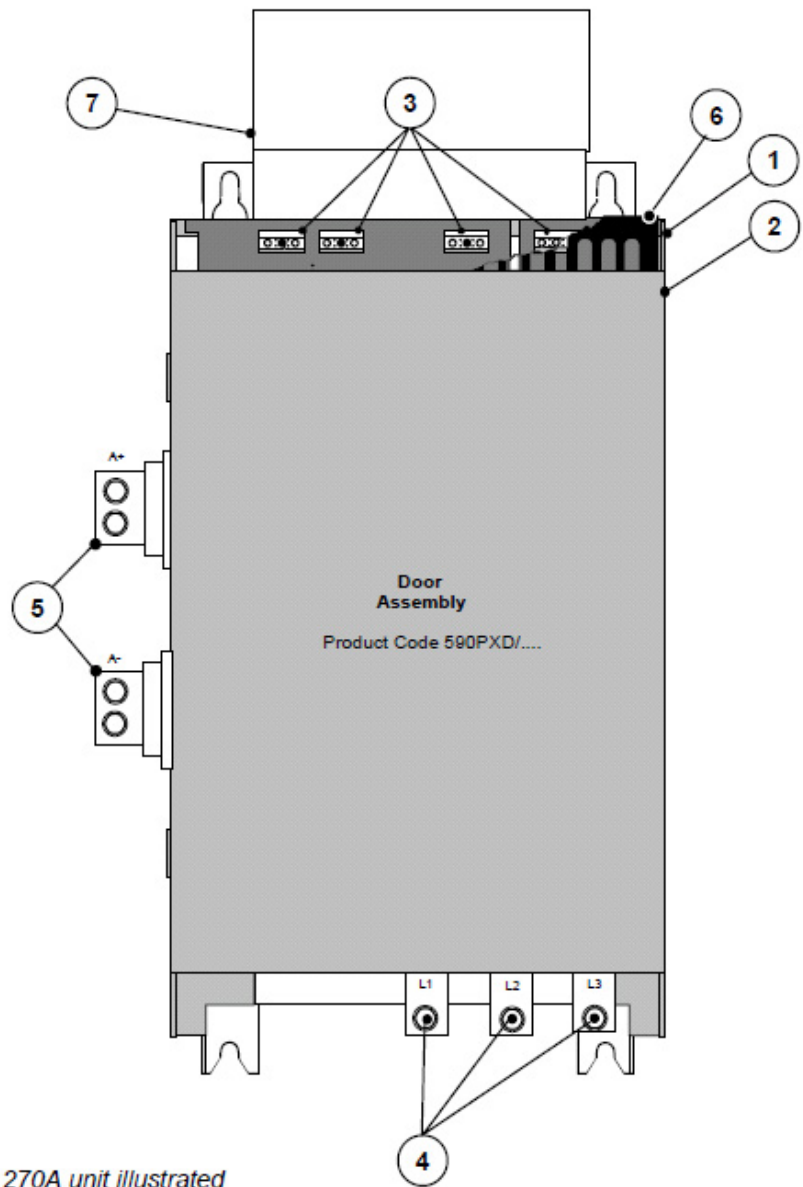

DC Drives - Integrator Series

DC590+ Integrator Series 2

Overview of Frames 4 and 5

1	Main drive assembly
2	Standard door assembly
3	Motor field terminals
4	Busbars - main power input
5	Busbars - main power output
6	Auxiliary supply, contactor and motor thermostat terminals
7	Frame 4 external vent (where fitted)
8	Contactor control select
9	Frame 5 External vent (where fitted)
10	Terminal cover (frame 5)

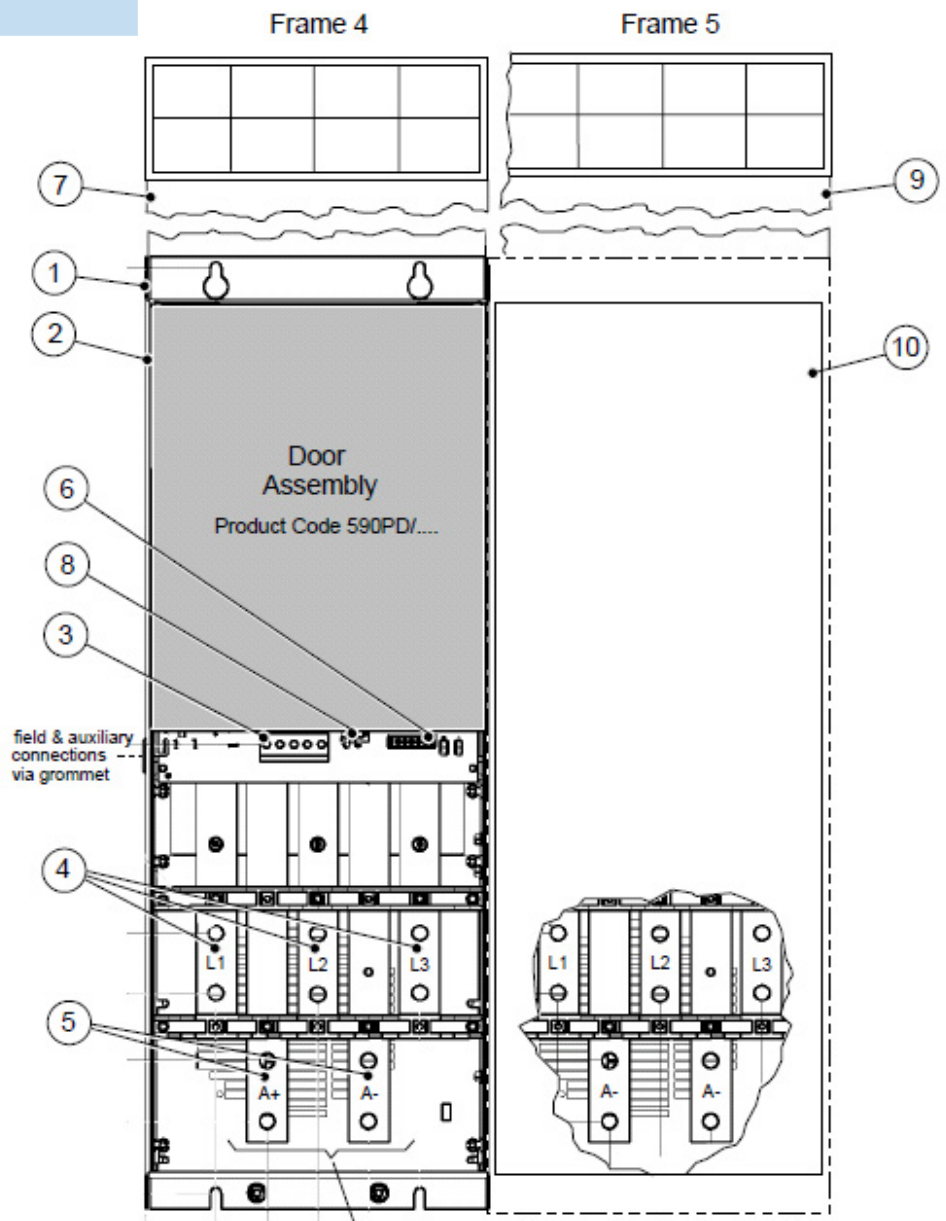

When Frame 5, both terminals are for A+ connections

DC Drives - Integrator Series

DC590+ Integrator Series 2

Overview of Frame 6

1	Phase assemblies - L1, L2, L3
2	Fishplate
3	Control panel assembly
4	Front cover
5	Standard door assembly
6	Field controller
7	Busbars - main power input
8	Busbars - main power output

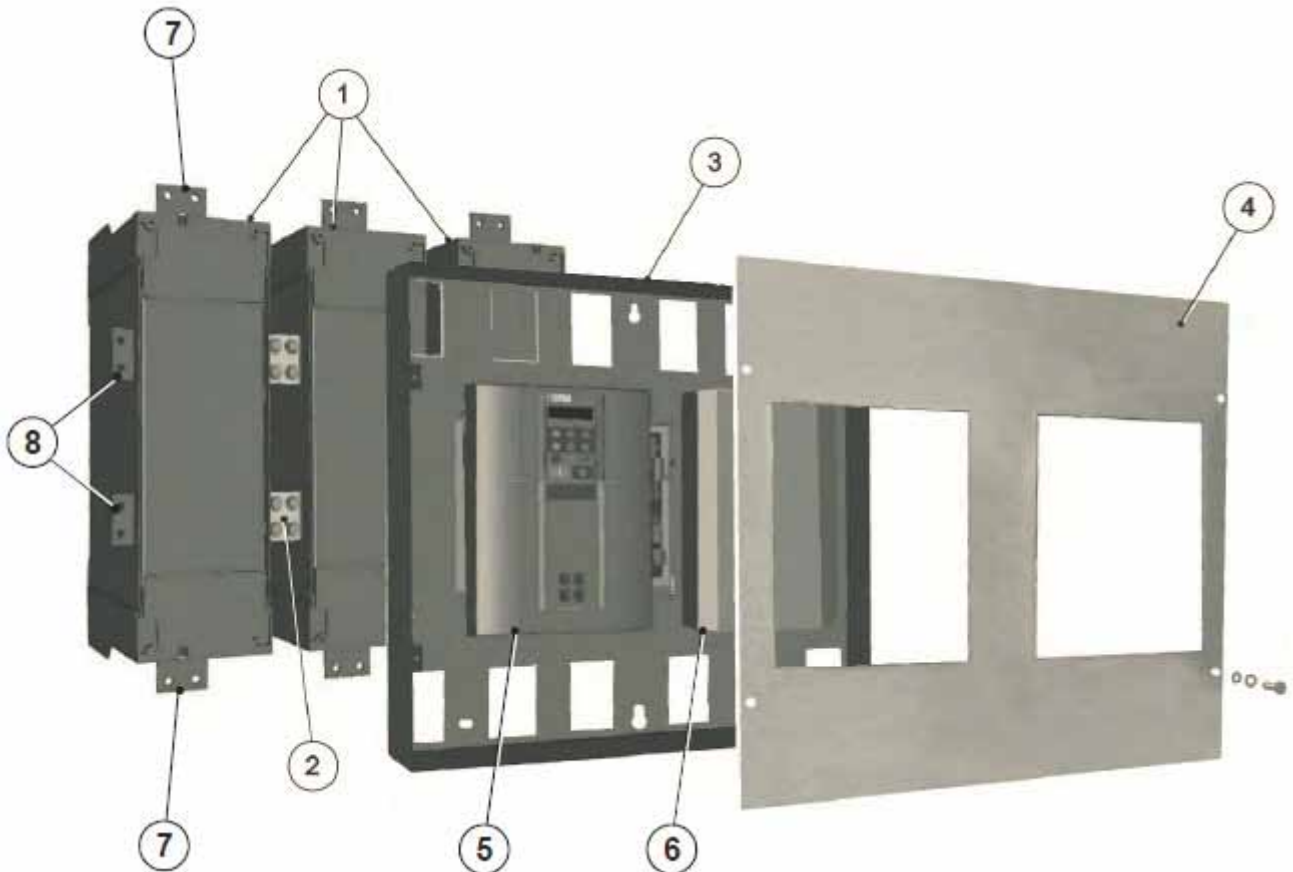

DC Drives - Integrator Series

DC590+/DC591+ and DRV Series

Electrical characteristics



DC590+/DC591+ DC Drives

Voltage	Output current (A)		Field current max (A)	Frame	New order code (1)	Old reference (1)
	Continuous 100% without overload	Overload 150% x 30sec 200% x 10sec				
110V - 220V	15	15	4	1	590P-2321501...	590P-0015-...
	35	35	4	1	590P-2323501...	590P-0035-...
	40	40	10	2	590P-2324002...	590P-0040-...
	70	70	10	2	590P-2327002...	590P-0070-...
	110	110	10	2	590P-2331102...	590P-0110-...
	165	165	10	2	590P-2331652...	590P-0165-...
	180	180	10	3	590P-2331803...	590P-0180-...
	270	270	10	3	590P-2332703...	590P-0270-...
	420	380	30	4	590P-2333804...	590P-0380-...
	550	500	30	4	590P-2335004...	590P-0500-...
	800	725	30	4	590P-2337254...	590P-0725-...
	910	830	30	4	590P-2338304...	590P-0830-...
1740	1580	30	5	590P-2341585...	590P-1580-...	
220V - 500V	15	15	4	1	590P-5321501...	590P-0015-...
	35	35	4	1	590P-5323501...	590P-0035-...
	40	40	10	2	590P-5324002...	590P-0040-...
	70	70	10	2	590P-5327002...	590P-0070-...
	110	110	10	2	590P-5331102...	590P-0110-...
	165	165	10	2	590P-5331652...	590P-0165-...
	180	180	10	3	590P-5331803...	590P-0180-...
	270	270	10	3	590P-5332703...	590P-0270-...
	420	380	30	4	590P-5333804...	590P-0380-...
	550	500	30	4	590P-5335004...	590P-0500-...
	800	725	30	4	590P-5337254...	590P-0725-...
	910	830	30	4	590P-5338304...	590P-0830-...
	1200	1050	60	H	590P-534120H...	590P-1200-...
	1350	1250	60	6	590P-5341256...	
	1700	1450	60	H	590P-534170H...	590P-1700-...
	1740	1580	30	5	590P-5341585...	590P-1580-...
	1750	1600	60	6	590P-5341606...	
	2150	1950	60	6	590P-5341956...	
2200	2000	60	H	590P-534220H...	590P-2200-...	
2700	2400	60	H	590P-534270H...	590P-2700-...	

(1) The references are for 4Q drives

For 2Q drives, replace "590P" for "591P" and "955R" for "955N" respectively

DC Drives - Integrator Series

DC590+/DC591+ and DRV Series

Electrical characteristics



DC590+/DC591+ DC Drives

Voltage	Output current (A)		Field current max (A)	Frame	New order code (1)	Old reference (1)
	Continuous 100% without overload	Overload 150% x 30sec 200% x 10sec				
500V - 600V	420	380	30	4	590P-6333804...	590P-0380-...
	550	500	30	4	590P-6335004...	590P-0500-...
	800	725	30	4	590P-6337254...	590P-0725-...
	910	830	30	4	590P-6338304...	590P-0830-...
	1740	1580	30	5	590P-6341585...	590P-1580-...
500V - 690V	1200	1050	60	H	590P-734120H...	590P-1200-...
	1350	1250	60	6	590P-7341256...	
	1700	1450	60	H	590P-734170H...	590P-1700-...
	1750	1600	60	6	590P-7341606...	
	1950	1850	60	6	590P-7341956...	
	2200	2000	60	H	590P-734220H...	590P-2200-...
	2700	2400	60	H	590P-734270H...	590P-2700-...

DRV Drives

Voltage	Output current (A)		Field current max (A)	Frame	New order code (1)	Old reference (1)
	Continuous 100% without overload	Overload 150% x 30sec 200% x 10sec				
220V - 500V	15	15	4	1	955R-5321501...	590P-0015-500-011-DRV
	35	35	4	1	955R-5323501...	590P-0035-500-011-DRV
	40	40	10	2	955R-5324002...	590P-0040-500-011-DRV
	70	70	10	2	955R-5327002...	590P-0070-500-011-DRV
	110	110	10	2	955R-5331102...	590P-0110-500-011-DRV
	165	165	10	2	955R-5331652...	590P-0165-500-011-DRV

(1) The references are for 4Q drives

For 2Q drives, replace "590P" for "591P" and "955R" for "955N" respectively

Selection and Order Codes

DC590+ Integrator Series 2, 110V -500V 3 phase

		Block 1	Block 2	Block 3	Block 4	
Example ▶		590P	- 23	2150 1 0	- P 00 - U 0 A 0	
Product Family	DC590+ Series DC Digital Drive - 4 quadrant regenerative	590P				
	DC591+ Series DC Digital Drive - 2 quadrant non-regenerative	591P				
	Supply Voltage	Output current (A)	Frame			
	110-220V 3 phase			23		
Current / Power Rating		15	1	2150	1	
		35	1	2350	1	
		40	2	2400	2	
		70	2	2700	2	
		110	2	3110	2	
		165	2	3165	2	
		180	3	3180	3	
		270	3	3270	3	
		380	4	3380	4	
		500	4	3500	4	
		725	4	3725	4	
		830	4	3830	4	
		1580	5	4158	5	
		220-500V 3 phase			53	
			15	1	2150	1
			35	1	2350	1
			40	2	2400	2
			70	2	2700	2
			110	2	3110	2
			165	2	3165	2
		180	3	3180	3	
		270	3	3270	3	
		380	4	3380	4	
		500	4	3500	4	
		725	4	3725	4	
		830	4	3830	4	
		1580	5	4158	5	
		1250	6	4125	6	
		1600	6	4160	6	
		1950	6	4195	6	
		1200	H	4120	H	
		1700	H	4170	H	
		2200	H	4220	H	
		2700	H	4270	H	
Auxiliary Supply	Universal 115V-230V 1ph (Frames 1, 2, 6 & H)				0	
	115V 1ph (Frames 3 - 5)				1	
	230V 1ph (Frames 3 - 5)				2	
Mounting	Panel mounting				P	
	Panel mounting + Airflow kit (option on Frames 4 & 5 only)				A	
Special Options	None				00	
	Documented special options (01-99) (refer to local sales office)					
Languages	English (50/60Hz)				U	
	German				D	
	Spansih				E	
	French				F	
	Italian				I	
Keypad	None				0	
	6901 keypad fitted				4	
Speed Feedback	Analogue tachometer				A	
	Glass fibreoptic encoder				G	
	Plastic fibreoptic encoder				P	
	Armature voltage				V	
	Wire-ended encoder				W	
Communications	None				0	
	ControlNet				C	
	DeviceNet				D	
	Ethernet				E	
	Link				L	
	ModBus +				M	
	CanOpen				N	
	Profibus				P	
	RS485/RS422				R	

Selection and Order Codes

DC590+ Integrator Series 2, 110V -500V 3 phase



500V-690V 3 phase

		Block 1	Block 2	Block 3	Block 4
		Example ▶ 590P	- 63 3380 4 2	- P 00	- U 0 A 0
Product Family	DC590+ Series DC Digital Drive - 4 quadrant regenerative DC591+ Series DC Digital Drive - 2 quadrant non-regenerative	590P 591P			
Current / Power Rating	Supply voltage				
	500-600V 3ph		63		
		380	4	3380 4	
		500	4	3500 4	
		725	4	3725 4	
		830	4	3830 4	
		1580	5	4158 5	
	500-690V 3ph		73		
		1250	6	4125 6	
		1600	6	4160 6	
	1950	6	4195 6		
	1200	H	4120 H		
	1700	H	4170 H		
	2200	H	4220 H		
	2700	H	4270 H		
Auxiliary Supply	Universal 115V-230V 1ph (Frames 1, 2, 6 & H) 115V 1ph (Frames 3 - 5) 230V 1ph (Frames 3 - 5)			0 1 2	
Mounting	Panel mounting Panel mounting+ Airflow kit (option sur Frames 4 & 5 only)			P A	
Special Options	None Documented special options (01-99) (refer to local sales office)			00	
Languages	English (50/60Hz) German Spanish French Italian				U D E F I
Clavier	None 6901 keypad fitted				0 4
Retour vitesse	Analogue tacho Glass fibreoptic encoder Plastic fibreoptic encoder Armature voltage Wire-ended encoder				A G P V W
Communications	None ControlNet DeviceNet Ethernet Link ModBus + CanOpen Profibus RS485/RS422				0 C D E L M N P R

Selection and Order Codes

DC590+ Integrator Series 2, Frame 6



DC590+ Series - Frame 6 Phase Assembly

		Block 1	Block 2	Block 3
		Example ▶ 590PL	- 53 4125 6 0	- P 00
Product Family	DC590+ Series DC Digital Drive - 4Q regenerative phase limb DC591+ Series DC Digital Drive - 2Q non-regenerative phase limb	590PL 591PL		
	Supply voltage			
	220-500V 3ph		53	
Ratio courant/ puissance		1250	6	4125 6
		1600	6	4160 6
		1950	6	4195 6
	500-690V 3ph		73	
		1250	6	4125 6
		1600	6	4160 6
		1850	6	4185 6
Auxiliary Supply	None			0
Mounting	Panel mounting			P
Special options	None			00
	Documented special options (01-99) (refer to local sales office)			

DC590+ Series - Frame 6 Control Phase Assembly

		Block 1	Block 2	Block 3	Block 4
		Example ▶ 590PG	- 53 0000 6 0	- P 00	- U 4
Product Family	SC590+ Series DC Digital Drive - Frame 6 Gantry	590P			
	Supply voltage				
	220-500V 3ph		53		
Current / Power Ratings		6		0000 6	
	500-690V 3ph		73		
		6		0000 6	
Auxiliary Supply	Universal 115V-230V 1ph			0	
Mounting	Panel mounting				P
Special Options	None				00
	Documented special options (01-99) (refer to local sales office)				
Languages	English (50/60Hz) German Spanish French Italian				U D E F I
Keypad	6901 keypad installed				4

Selection and Order Codes

DC590PX+ Integrator Series 2



		Block 1	Block 2	Block 3	Block 4
		Example ▶ 590PX - 23	2350 1 0	- P 00	- U 0 A 0
Product family	DC590PX Series DC Digital Drive - regenerative	590PX			
	DC591PX Series DC Digital Drive - non-regenerative	591PX			
	Supply voltage	Output current (A)	Frame Size		
Current / Power Ratings	110-220V 3ph		23		
		35	1	2350 1	
		70	1	2700 1	
		110	1	3110 1	
		150	1	3150 1	
	220-500V 3ph		53		
		35	1	2350 1	
		70	1	2700 1	
		110	1	3110 1	
		150	1	3150 1	
Auxiliary Supply	Universal 115V-230V 1ph (35/70 Amp ratings only)			0	
	115V 1ph (110/150 Amp ratings only)			1	
	230V 1ph (10/150 Amp ratings only)			2	
Mounting	Panel mounting			P	
Special Options	None			00	
	Documented special options (01-99) (refer to local sales office)				
Languages	English (50/60Hz)				U
	German				D
	Spanish				E
	French				F
	Italian				I
Keypad	None				0
	6901 keypad installed				4
Speed Feedback	Analogue tachometer				A
	Glass fibreoptic encoder				G
	Plastic fibreoptic encoder				P
	Armature voltage				V
	Wire-ended encoder				W
Communications	None				0
	ControlNet				C
	DeviceNet				D
	Ethernet				E
	Link				L
	ModBus +				M
	CanOpen				N
	Profibus				P
	RS485/RS422				R

Selection and Order Codes

DRV Ready to Install DC Drive



		Block 1	Block 2	Block 3	Block 4	
		Example ▶ 955R	- 53	2150 1 1	- P 00 - U 0 A 0 00	
Product Family	DC590+ DRV Series DC Digital Drive - regenerative	955R				
	DC590+ DRV Series DC Digital Drive - non-regenerative	955N				
	Supply voltage					
	Output Current (A)					
	HP					
	Frame Size					
	500V 3ph		53			
Current / Power Ratings		7	15	7.5	1	2150 1
		15	35	20	1	2350 1
		18	40	25	2	2400 2
		22	55	30	2	2550 2
		30	70	40	2	2700 2
		37	90	50	2	2900 2
		45	110	60	2	3110 2
		55	125	75	2	3125 2
		75	165	100	2	3165 2
Auxiliary Supply	115V 1ph				1	
	230V 1ph				2	
Mounting	Panel mounting (Frames 1 & 2)				P	
Special Options	None				00	
	Documented special options (01-99) (refer to local sales office)					
Languages	English (50/60Hz)				U	
	German				D	
	Spanish				E	
	French				F	
	Italian				I	
Keypad	None				0	
	6901 keypad installed				4	
Speed Feedback	Analogue tachometer				A	
	Glass fibreoptic encoder				G	
	Plastic fibreoptic encoder				P	
	Armature voltage				V	
	Wire-ended encoder				W	
Communications	None				0	
	ControlNet				C	
	DeviceNet				D	
	Ethernet				E	
	Link				L	
	ModBus +				M	
	CanOpen				N	
	Profibus				P	
	RS485/RS422				R	
Motor Blower	No blower overload				00	
	0.10 - 0.16A				01	
Current Overload	0.16 - 0.25A				02	
	0.25 - 0.4A				04	
	0.4 - 0.63A				06	
	0.63 - 1.0A				10	
	1.0 - 1.6A				16	
	1.6 - 2.5A				25	
	2.5 - 4.0A				40	
	4.0 - 6.3A				63	

Selection and Order Codes

DC590+ Series 2 External Stack Controllers



		Block 1	Block 2	Block 3	Block 4
		Example ▶ 598P	- 23 2600 1 0	- A P 00	- U 0 A 0
Product family	DC598+ External Stack Controller - 2Q non-regenerative	598P			
	DC599+ External Stack Controller - 4Q Regenerative	599P			
Current / Power Ratings	Supply Voltage				
	110-220V 3ph		23		
		60	1	2600 1	
		120	1	3120 1	
	220-500V 3ph		53		
		60	1	2600 1	
		120	1	3120 1	
	500-690V 3ph		73		
	60	1	2600 1		
	120	1	3120 1		
Auxiliary Supply	Universal 115V-230V 1ph (60 Amp rating only)			0	
	115V 1ph (120 Amp rating only)			1	
	230V 1ph (120 Amp rating only)			2	
Trigger Option	Amplifiers			A	
	Trigger			T	
Mounting	Panel mounting			P	
Special Options	None				00
	Documented special options (01-99) (refer to local sales office)				
Languages	English (50/60Hz)				U
	German				D
	Spanish				E
	French				F
	Italian				I
Keypad	None				0
	6901 keypad installed				4
Speed Feedback	Analogue tacho				A
	Glass fibreoptic encoder				G
	Plastic fibreoptic encoder				P
	Armature voltage				V
	Wire-ended encoder				W
Communications	None				0
	ControlNet				C
	DeviceNet				D
	Ethernet				E
	Link				L
	ModBus +				M
	CanOpen				N
	Profibus				P
	RS485/RS422				R

Accessories and Options

DC590+ Integrator Series 2 DC Drives



Options	Fitting	Order Reference	Page	
Operator Keypad				
1	DC590+ keypad (removable)	Option	6901-00-G	33
	Advanced operator keypad (removable)	Option	6911-01-00-G	
	Remote mounting kit	Option	6052/00	
2 Communication Cards				
	Ethernet Modbus/TCP and Ethernet IP	Option	6055-ETH-00	31
	ControlNet	Option	6055-CNET-00	
	Modbus Plus	Option	6055-MBP-00	
	DeviceNet	Option	6055-DNET-00	
	RS485 / Modbus	Option	6055-EI00-00	
	Profibus-DP	Option	6055-PROF-00	
	CANopen DS402	Option	6055-CAN-00	
	LonWorks	Option	6055-LON-00	
	Link	Option	6055-LINK-00	
3 Speed Feedback Cards				
	Wire-ended encoder Card	Option	AH387775U001	32
	Analogue Tacho	Option	AH385870U001	
	Glass fibreoptic Microtach encoder	Option	AH386025U001	
	Plastic fibreoptic Microtach encoder	Option	AH386025U00	
4 Drive Doors				
	Door for frames 3 & H (with additional motor thermistor terminals)	Standard	590PXD-0010-UK	
	Door for Frames 4 & 5	Standard	590PD-0010-UK	
Accessories				
	DC Line Chokes			41
	HMI touchscreen displays 3 to 15"			34
	DSI programming software			38
	DSE programming software			48
	Microtach encoder			47
Motors				
	DC motors			42



Accessories and Options

DC590+ Integrator Series 2 DC Drives Communication Cards



The communication cards allow the DC590+ to be connected to the most common industry standard fieldbuses.

Features

- Communication cards can be factory fitted or purchased separately for fitting on-site
- Dimensions H x W D: 127mm x 76.2mm x 25.4mm
- LED indication of network and card status

Ethernet Communications Interface

Order Code: 6055-ETH-00	
Supported Protocols	Modbus/TCP and Ethernet IP
Communication Speed	10/100M bits/s
Station Address	Selectable via switch or Internet Explorer
Suitable for	DC590+ version 7.1+

ControlNet Communications Interface

Order Code: 6055-CNET-00	
Supported Messages	Polled I/O
Station Address	Selectable via software
Suitable for	DC590+ version 5.17+

Devicenet Communications Interface

Order Code: 6055-DNET-00	
Supported Protocols	DeviceNet Drive Profile – Group 2 slave only
Station Address	DeviceNet Drive Profile – Group 2 slave only
Suitable for	DC590+ version 5.x+

Modbus Plus Communications Interface

Order Code: 6055-MBP-00	
Supported Protocols	Modbus Plus
Cabling	RS485 2 or 4 wire
Communication Speed	1 M bits/s
Station Address	Selectable via software
Suitable for	DC590+ version 7.1+

CANopen Communications Interface

Order Code: 6055-CAN-00	
Profile	DS402
Supported Messages	SDO, PDO, NMT, SYNC
Communication Speed	20K, 50K, 125K, 250K, 500K, 1M bits/s selectable
Station Address	Selectable via Switch
Suitable for	DC590+ version 5.x+

Profibus-DP Communications Interface

Order Code: 6055-PROF-00	
Supported Protocols	Profibus-DP
Communication Speed	Automatically detected
Station Address	Selectable via software
Suitable for	DC590+ version 5.x+

RS485/Modbus Communications Interface

Order Code: 6055-EI-00	
Supported Protocols	Modbus RTU, EI Bisynch ASCII
Cabling	RS485 2 or 4 wire
Communication Speed	300 to 115200 bits/s
Station Address	Selectable via software
Suitable for	DC590+ version 5.17+

Accessories and Options

DC590+ Integrator Series 2 DC Drives

Encoder feedback card

Description

The encoder feedback card allows an incremental encoder to be fitted to the drive to provide accurate measurement of motor speed. The card also provides the encoder power supply.

Specifications

Maximum input frequency	100KHz
Receiver current consumption	10mA per channel
Input format	2 channel differential and quadrature
Differential input voltage	Minimum 3.5V
Encoder power output	+5V to 24V adjustable (AH387775U001)
Power supply rating	2W maximum
Power supply load	1.4 x output power
Terminal size	16 AWG maximum
Tightening torque	0.4Nm

Order Codes

Order Code	Description
AH387775U001	Encoder Card - Adjustable supply
AH387775U005	Encoder Card +5Vdc
AH387775U012	Encoder Card +12Vdc
AH387775U015	Encoder Card +15Vdc
AH387775U024	Encoder Card +24Vcc

Accessories and Options

DC590+ Integrator Series 2 DC Drives

Operator Keypads

Standard operator keypad 6901-00-G

Features

- Local motor control : start, speed, direction, diagnostics
- Operator menus and parameter configuration
- Quick setup menu
- Password protection for parameter configuration

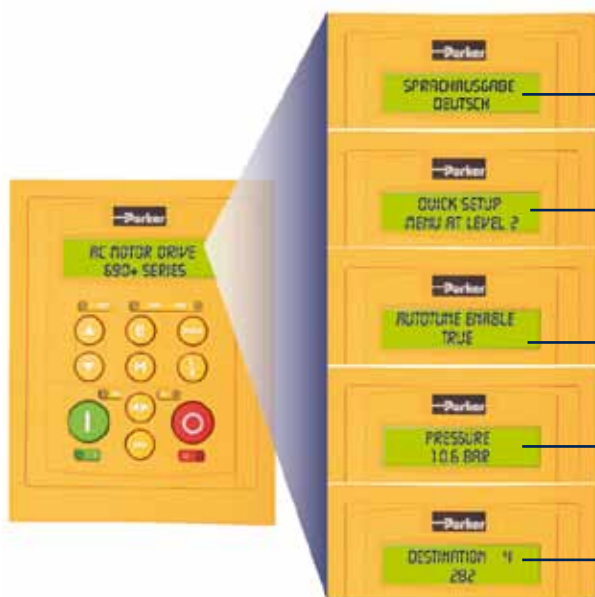

Multilingual

English · French · German · Italian · Portuguese · Swedish · Polish

Quick setup menu

Intuitive menus allowing easy and quick setup of the drive

Auto-tuning

Automatic tuning of motor parameters ensures maximum dynamic motor performance

Diagnostics messages

Display input and output parameters as well as drive operating units

Drive configuration

Advanced operator keypad 6911-01-00-G

Features

- 128 x 64 pixels semi-graphical resolution
- RS232 and RS485 ports
- Recording of parameters to keypad and restore to drive (Memory card 256Mb to 2Gb)



Accessories and Options

DC590+ Integrator Series 2 DC Drives

Drive System Explorer Lite (DSE Lite) Software

Description

DSE LITE software is an easy to use configuration, commissioning and monitoring tool with graphical interface for the Parker SSD Drives range of AC and DC drives.

While the drive is in running mode the oscilloscope function allows “on-line” monitoring of selected parameters and the recording of trends.

DSE LITE, allows the user to create, parameterize and configure user defined applications thanks to function blocks dedicated to speed control, Winder, PID, Diameter calculator, Shaftless...

DSE LITE is downloadable from our website.
www.parker.com

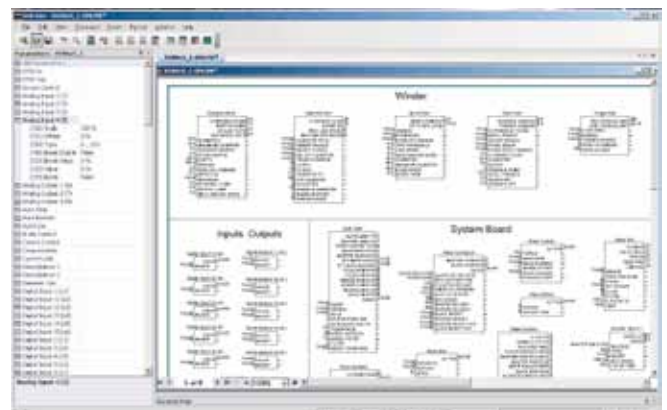
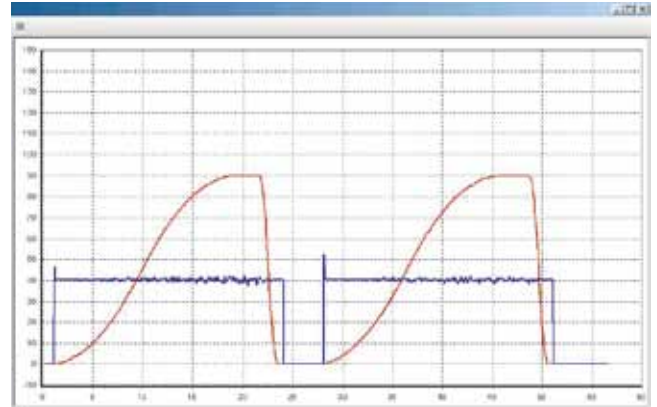

Accessories and Options

DC590+ Integrator Series 2 DC Drives
TS8000 Series Touchscreens



Description

TS8000 is a high performance HMI touchscreen range with powerful features that would normally only be found in PC-based displays.

The TS8000 is able to communicate with many different pieces of hardware through its 10/100Base-T Ethernet port.

Furthermore a USB programming port allows programs to be downloaded, or access to trending and data logging, while data can be collected and stored on a standard CompactFlash card, freeing up internal memory.

- Multi-lingual graphical interface**
- Built-in symbol library of common objects**
- Built-in web server**
- CompactFlash support**
- Integrated automatic multiple protocol conversion**
- Free programming software**

Technical specifications

Power Supply	24Vdc ±20%
Operating Temperature	0-50°C
Relative Humidity	80% non-condensing
Altitude	2000 m
Enclosure	IP66 / Nema 4
Keypads	<p>TS8003 :</p> <ul style="list-style-type: none"> . 8 user assignable keys . 5 navigation keys . 12 numeric keys . 7 dedicated keys <p>TS8006 : 5 keys for on screen menus</p> <p>TS8008 : 7 keys for on screen menus</p> <p>TS8010 : 8 keys for on screen menus</p> <p>TS8015 : 9 keys for on screen menus</p>
Memory	CompactFlash slot
Communication Ports	<p>Programming :</p> <ul style="list-style-type: none"> . USB 1.1 - connector type B . RS232 - via RJ12 <p>Communication :</p> <ul style="list-style-type: none"> . RS232 - via RJ12 . RS485 - via RJ45 . Ethernet 10/100 Base T - connector RJ45

HMI Specifications

Model	Screen	Colour	Number of Pixels
TS8003	32"/FSTN	2	128 x 64
TS8006	5.7"/TFT	256 QVGA	320 x 240
TS8008	7.7"/DSTN	256 VGA	640 x 480
TS8010	10.4"/TFT		
TS8015	15"/TFT	32,000 XGA	1024 x 768

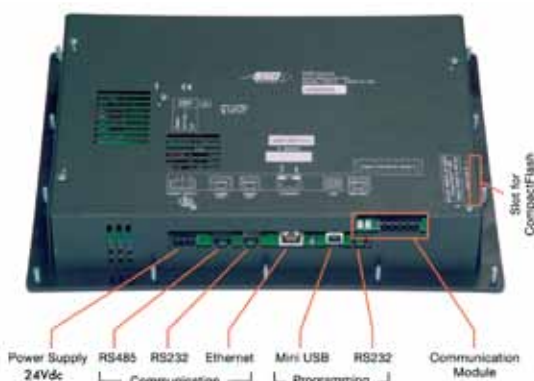

Accessories and Options

DC590+ Integrator Series 2 DC Drives TS8000 Communications Cards



Description

The TS8000 communication cards allow connection and integration of the TS800 into many popular fieldbus communication networks.

Features

Configuration	by means of DSI8000 configuration software
Power Supply	Connection by pluggable 3-pin terminals
Operating Temperature	0 to 50°C
Storage Temperature	-20 to 80°C
Humidity	80% max. relative humidity (non-condensing) from 0 to 50°C
Altitude	2000 metres Max.

CANopen Communications Interface

Order Code: 8000-CB-00

Supported Protocols	<ul style="list-style-type: none"> CANopen SDO Master
Communication Speed	<ul style="list-style-type: none"> Selectable by software up to 1 Mbits/s
Communication	<ul style="list-style-type: none"> With Drive System Explorer software using RTNX protocol
Suitable for drives	<ul style="list-style-type: none"> AC890 version 3.2+

DeviceNet Communications Interface

Order Code: 8000-DN-00

Supported Protocols	<ul style="list-style-type: none"> DeviceNet – Slave Group 2 only
Communication Speed	<ul style="list-style-type: none"> Selectable by software up to 500 kbits/s

Firewire Communications Interface

Order Code: 8000-FA-00

This card allows data exchange between the TS8000 and an AC890 fitted with an 8903-FA-00 Interface

Communication Ports	Port A : IEEE 1394A Port B : IEEE 1394B
---------------------	--

Note : The TS8000 must use a Class 2 or SELV rated power supply

Link Communications Interface

Order Code: 8000-CB-00

Supported Protocols	LINK
Communication Speed	2.7Mbits/s

Allows data exchange between TS8000 and SSD LINK fibre optic network

Profibus-DP Communications Interface

Order Code: 8000-PB-00

Supported Protocols	EN50 170, 1
Communication Speed	Up to 12 Mbits/s

EMC Filters

for DC Drives

Description

A range of custom designed optional EMC (Electromagnetic Compatibility) filters are available for use with Parker SSD Drives product range.

They are used to help achieve conformance with the EMC directive BS EN 61800-3:2004 - "Adjustable speed electrical power drive systems - Part 3".

Installation of the drive must be in accordance with the installation guidelines in the product manual. The filters comply with the relevant standards as outlined in the following table.

1st Environment : Drives directly connected without intermediate transformers to a low voltage (<100V rms) supply network that is part of a network that also supplies buildings used for domestic purposes.

2nd Environment : Establishments where there is no direct connection to a low voltage supply network that also supplies buildings used for domestic purpose.

TN Earthing = Grounded neutral AC supply <460V ac

IT Earthing = Ungrounded neutral AC supply <500V ac

Ext. Filter = External filter

Ext. Filter FP = Footprint external filter

EMC Filters

DC Drives	Frame	Current	2 nd Environment (Industrial)	1 st Environment (Domestic)
506,507,508			External FP Filter C0389115	External FP Filter C0389115
512,514C		4, 8, 16A	External FP Filter C0389113	External FP Filter C0389113
		32A	External FP Filter C0389114	External FP Filter C0389114
DC590+	1	15A	Standard with input capacitors	External Filter CO467844U015
		35,40A	Standard with input capacitors	External Filter CO467844U040
	2	70A	Standard with input capacitors	External Filter CO467844U070
		110A	Standard with input capacitors	External Filter CO467844U110
	3	165A	Standard	External Filter CO467844U165
		180A	Standard	External Filter CO467844U180
	4, 5, H	270A	Standard	External Filter CO467844U340
			Standard	Refer to your local sales office

Wall Mounting : Use the mounting kits below

Filter	Mounting Kit
CO467842U020	BA467840U020
CO467842U044	BA467840U044
CO467842U084	BA467840U084
CO467842U105	BA467840U105



Drive mounted on an external footprint filter



EMAC s.r.o.
Kasarenska 2404/26
911 05 Trencin
SLOVAKIA

Parker certified distributor
+421 32 3810 232
info@emac.sk
www.emac.sk